

RECAMBIOS Y ACCESORIOS **2016**

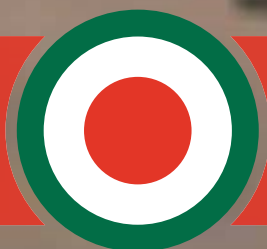

KURITA®

BAYGAR



KUIRID®



RECAMBIOS Y ACCESORIOS 2016

Motogarden S.A. se reserva el derecho a cambiar o modificar cualquier especificación de sus precios o productos sin aviso previo. Todas las fotos son con fines ilustrativos. Tarifa válida salvo error tipográfico o fin de existencias. Todos los precios netos que aparecen en el catálogo son precios netos de venta sin IVA. Tarifa válida hasta 31/08/2016, salvo impresión de otra nueva tarifa antes de esta fecha.

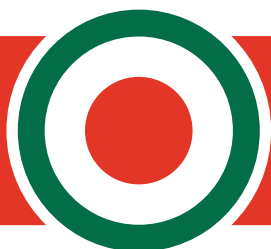

KUJRID®

BAYGAR

RECAMBIOS Y ACCESORIOS VARIOS

ACCESORIOS MOTOR	6
AGUJAS CARBURADOR	6
CAJAS VARIADAS	7
CONDENSADORES	8
CUERDAS DE ARRANQUE	8
FUSIBLES	9
HERRAMIENTAS DE CORTE	9
HERRAMIENTAS DE TALLER	10
KITS DE REPARACIÓN DE CARBURADORES	11
PUÑOS DE ARRANQUE	18
RODAMIENTOS	20
RODAMIENTOS SKF	21
RODAMIENTOS CON ALETAS	22
SEGMENTOS	22
TUBOS DE GASOLINA	23

ACCESORIOS MOTOSIERRAS

ROLLOS CADENA	26
REMACHES CADENA	26
CADENAS CORTADAS	27
ESPADAS	28
PUNTERAS	29
CORONAS PIÑONES	29
PIÑONES	30
KIT CARVING	31
ACCESORIOS MOTOSIERRA VARIOS	31
AFILADORAS ELÉCTRICAS	33
SOPORTE PARA TRONCOS	33

RECAMBIOS MOTOSIERRAS

AMORTIGUADORES	36
ARANDELAS Y PRESILLAS	40

ASAS	40
BOBINAS DE ENCENDIDO	41
BOMBAS DE ENGRASE	43
BRIDAS/CODOS DE ADMISIÓN	45
CABLES ACELERADOR	47
CAMPANAS DE EMBRAGUE	48
CAPOT	51
CAPUCHÓN DE BUJÍAS	51
CARBURADORES	52
CASQUILLO PALANCA DE FRENO	55
CEBADORES/BOMBINES CARBURADOR	55
CHAPA DE CADENA/CHAPA DE ENGRASE	55
CIGÜEÑALES	56
CONJUNTOS DE ARRANQUE	57
CORONAS	59
DEFLECTOR DE AIRE	59
DEPÓSITO DE GASOLINA	59
EMBRAGUES	60
ESCAPES	61
FILTROS DE ACEITE	62
FILTROS DE AIRE	63
FILTROS DE GASOLINA	66
FLEJES DE FRENO	66
GATILLOS Y SEGUROS	67
GUÍAS DE CADENA	68
INTERRUPTORES DE PARE	68
JUEGO JUNTAS DE MOTOR	70
KITS CILINDRO + PISTÓN	72
MUELLES DE ARRANQUE	75
MUELLES DE EMBRAGUE	77
MUELLES GATILLO	79
PALANCA DE FRENO	79
PISTONES	79
POLEAS DE ARRANQUE	80
RETENES CIGÜEÑAL	83
SEGMENTOS	84
SINFINES / PIÑONES DE ENGRASE	85
SOPORTES DE ESCAPE	86
TAPAS DE CADENA	86

TAPONES DE GASOLINA Y ACEITE	87
TENSORES DE CADENA	90
TIRADORES DE AIRE	91
TORNILLOS DE ESCAPE	92
TRINQUETES	93
TUBO IMPULSIÓN	94
TUBO DE ASPIRACIÓN DE ACEITE	94
TUBOS DE GASOLINA	95
TUERCAS DE CADENA	96
VÁLVULAS DE DESCOMPRESIÓN	96
VOLANTES DE INERCIA	96

ACCESORIOS DESBROZADORAS

NYLON	98
NYLON DENTADO	99
NYLON SARP	99
DISCOS WIDEA	100
DISCOS DESBROZADORA	100
PROTECTORES DISCO DESBROZADORA	101
ARNÉS DESBROZADORA	101
CAZOLETAS	101
CABEZALES NYLON	102
ADAPTADORES PARA CABEZALES	103
ACCESORIOS DESBROZADORA VARIOS	103
BARRA DESBROZADORA	104

RECAMBIOS DESBROZADORAS

BOBINAS DE ENCENDIDO	106
CABLES ACELERADOR	107
CAMPANA DE EMBRAGUE	108
CAPOT (GANCHO CAPOT)	108
CAPUCHÓN DE BUJÍAS	109
CARBURADORES	109
CEBADORES/BOMBINES CARBURADOR	111
CIGÜEÑALES	111
CONJUNTOS DE ARRANQUE	111

EJE TRANSMISIÓN	114
EMBRAGUES	114
ESCAPES	115
FILTROS DE AIRE	116
FILTROS DE GASOLINA	118
INTERRUPTORES DE PARE	119
JUEGO DE JUNTAS MOTOR	119
KITS CILINDRO + PISTÓN	120
KITS DE REPARACIÓN DE CARBURADOR	122
MANDO ACELERADOR	123
MUELLES DE ARRANQUE	123
MUELLES DE EMBRAGUE	124
PISTONES	124
POLEAS DE ARRANQUE	125
SEGMENTOS	127
TAPONES DE GASOLINA	128
TORNILLO EMBRAGUE	128
TRINQUETES	128
TUBO + TRANSMISIÓN	129

RECAMBIOS MAQUINARIA VARIA

AMORTIGUADORES	132
BRIDAS/CODOS DE ADMISIÓN	132
CABLE ACELERADOR	132
CARBURADORES	132
CIGÜEÑALES	133
EMBRAGUES	133
ESCAPES	133
FILTROS DE AIRE	133
JUEGO JUNTAS DE MOTOR	135
KIT CILINDRO + PISTÓN	136
MUELLES DE ARRANQUE	136
PISTONES	137
POLEAS DE ARRANQUE	137
RETENES CIGÜEÑAL	138
SEGMENTOS	138
TRINQUETES	138

**CORREAS
CORTACÉSPED**

CORREAS	140
---------	-----

**CUCHILLAS
CORTACÉSPED**

CUCHILLAS	144
SOPORTE DE CUCHILLAS	151
TORNILLOS, ARANDELAS, BUJES Y POLEAS CUCHILLA	155

**RECAMBIOS MOTORES
4 TIEMPOS**

ACCESORIOS MOTOR	160
AGUJAS CARBURADOR	160
BOBINAS DE ENCENDIDO	160
BOMBAS DE GASOLINA	161
BIELA MOTORES	162
BRIDA DE ADMISIÓN	162
CABLE ACELERADOR	163
CABLE DE PARE	164
CAPUCHONES DE BUJÍA	165
CARBURADORES	165
CASQUILLO TRACCIÓN	166
CEBADORES/BOMBINES CARBURADOR	167
CONJUNTOS DE ARRANQUE	167
DEPÓSITO DE GASOLINA	168
ESCAPES	168
FILTRO DE ACEITE	168
FILTRO DE AIRE	169
FILTROS DE GASOLINA	173
INTERRUPTOR DE PARE	174
JUEGO DE JUNTAS MOTOR	174
KIT DE VÁLVULAS Y AGUJAS DE CARBURADOR	176
LLAVES DE GASOLINA	176

MUELLES DE REGULACIÓN	177
SOLENOIDES	177
TUBOS DE GASOLINA	178
TAPONES DE GASOLINA	178

**ACCESORIOS
ALKO Y SOLO**

ACCESORIOS TRACTORES	182
----------------------	-----

**ACCESORIOS Y
ROPA DE PROTECCIÓN**

PANTALÓN DE PROTECCIÓN	184
BOTA DE PROTECCIÓN	184
GUANTES DE PROTECCIÓN	185
GAFAS DE PROTECCIÓN	185
ACCESORIOS DE PROTECCIÓN	186
MÁSCARAS DESECHABLES	187
ESPINILLERAS DE PROTECCIÓN	187

**ACCESORIOS Y
HERRAMIENTA DE PODA**

GUANTES DE PROTECCIÓN DE PODA	190
TIJERAS DE PODA	190

**BATERIAS Y
ACCESORIOS DE BATERÍA****ACEITES Y
TANQUES**

RECAMBIOS Y ACCESORIOS VARIOS

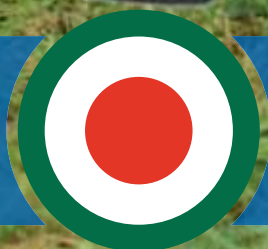

KUIRID®

BAYGAR

ACCESORIO MOTOR



Nº	Referencia	Descripción
1	12 13001	Cuenta revoluciones+cuenta horas. Válido para motores 2T+4T
2	28 13002	Manómetro
3	28 13003	Tope pistón plástico
4	28 13004	Tope pistón metal
5	28 13005	Kit montaje aros

Línea AZUL

AGUJAS DE CARBURADOR



Nº	Referencia	Descripción
1	12 32001	Aguja de admisión grande
2	12 32002	Aguja de admisión pequeña

Línea AZUL

CAJAS VARIADAS

Línea
AZUL



1



2



3



4



5



6



7



8



9

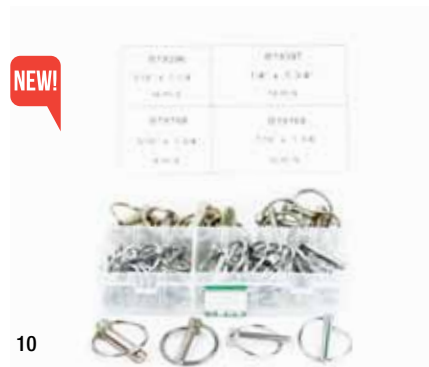

10

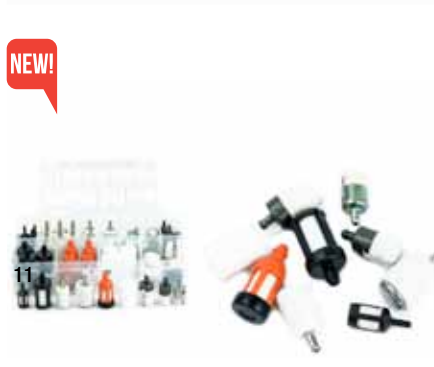

11



12

Nº	Referencia	Descripción	Nº unid./caja
1	12 13006	Caja variada de pasadores	555 unidades
2	12 13007	Caja variada de juntas tóricas	225 unidades
3	12 13008	Caja variada de presillas normales	300 unidades
4	12 13009	Caja variada de pasadores tipo R	150 unidades
5	12 13010	Caja variada de arandelas y tornillos. Rosca izquierda	120 unidades
6	12 13011	Caja variada de engrasadores	110 unidades
7	12 13012	Caja variada muelles de expansión	125 unidades
8	12 13013	Caja variada tornillos sin cabeza (tipo Allen)	150 unidades
9	12 13014	Caja variada presillas E-clips	300 unidades
10	12 13015	Caja variada pasadores	50 unidades
11	12 13016	Caja variada filtros-9 tipos	66 unidades
12	12 13017	Caja variada filtros y llaves de gasolina	40 unidades

CONDENSADORES



Nº	Referencia	Descripción
1	12 22001	Condensador estándar 6µF
2	12 22002	Condensador estándar 8µF
3	12 22003	Condensador estándar 10µF
4	12 22004	Condensador estándar 12µF
5	12 22005	Condensador estándar 16µF
6	12 22006	Condensador estándar 20µF

Linea AZUL

CUERDAS DE ARRANQUE



Nº	Referencia	Descripción
1	12 23001	3,0mmx100mx600g
	12 23002	3,5mmx100mx800g
	12 23003	4,0mmx100mx1000g
	12 23004	4,5mmx100mx1200g
	12 23005	5,0mmx100mx1400g

FUSIBLES

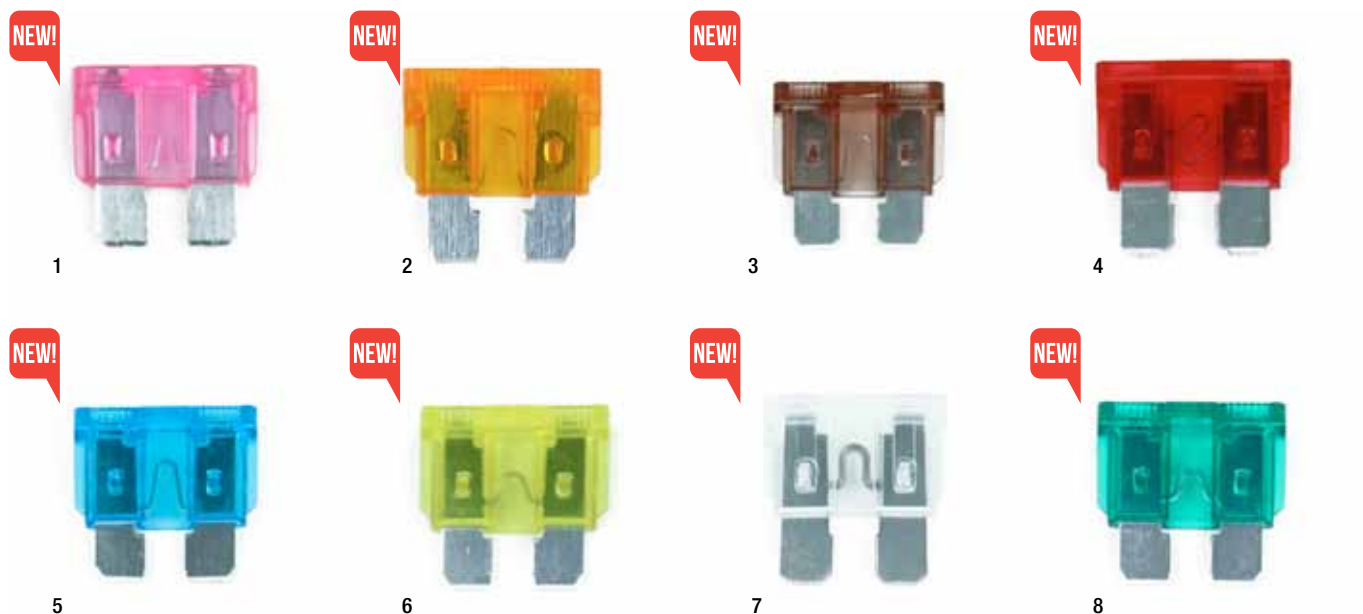

Nº	Referencia	Descripción	Nº unid./caja
1	12 22007	Caja fusibles 4 AMP (rosa)	10 unidades
2	12 22008	Caja fusibles 5 AMP (naranja)	10 unidades
3	12 22009	Caja fusibles 7,5 AMP (marrón)	10 unidades
4	12 22010	Caja fusibles 10 AMP (rojo)	10 unidades
5	12 22011	Caja fusibles 15 AMP (azul)	10 unidades
6	12 22012	Caja fusibles 20 AMP (amarillo)	10 unidades
7	12 22013	Caja fusibles 25 AMP (blanco)	10 unidades
8	12 22014	Caja fusibles 30 AMP (verde)	10 unidades

Línea AZUL

HERRAMIENTAS DE CORTE



Nº	Referencia	Descripción	Peso
1	78 13028	Hacha 360 mm	600 gramos
	78 13029	Hacha 430 mm	1000 gramos

HERRAMIENTAS DE TALLER



Nº	Referencia	Descripción
1	78 13018	Llave de bujía (Estándar) Medida: 19 x 13 mm
2	78 13019	Llave de bujía (Estándar) Medida: 19 x 17 mm
3	78 13020	Llave de bujía (Torx) Medida: 19 x 13 mm
4	78 13021	Llave de allen 3 mm
5	78 13022	Llave de allen 4 mm
6	78 13023	Llave de allen 5 mm
7	78 13024	Engrasador profesional 500 CC
8	78 13025	Bomba extracción de aceite 1 l.
9	78 13026	Bombín de pie. Compacto y resistente. Pedal antideslizante
10	78 13027	Bomba aire aluminio con manómetro 24"

Las referencias o alusiones a otras marcas hechas en el catálogo sólo son indicativas y sirven para la comprobación de nuestros productos. Suministramos SÓLO PIEZAS NO ORIGINALES.

RECAMBIOS Y ACCESORIOS VARIOS

KITS DE REPARACIÓN CARBURADORES (Tillotson)

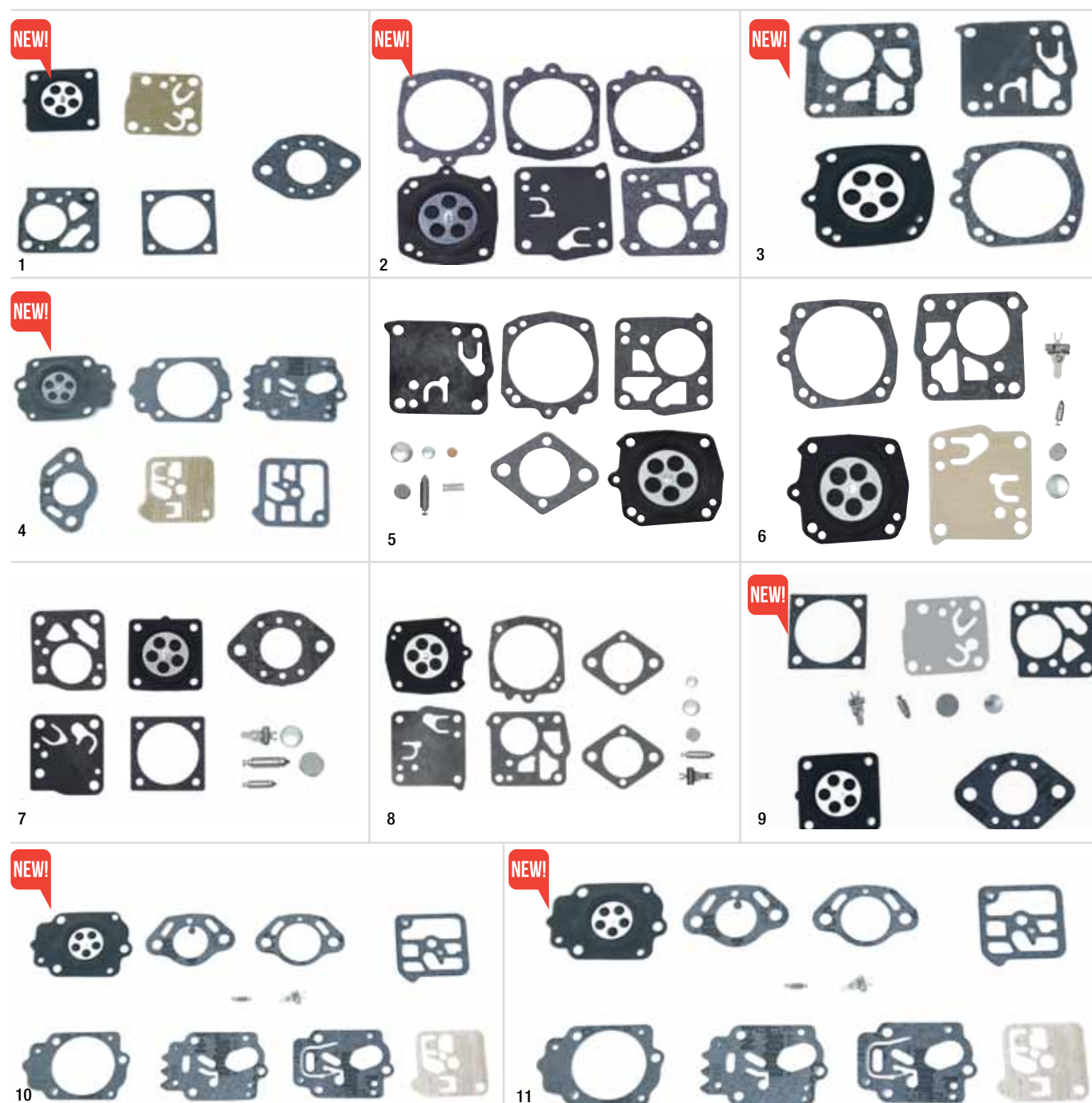

Nº	Referencia	Descripción	Ref. original
1	12 31086	Juego de membranas Tillotson DG-2HU	DG-2HU
2	12 31087	Juego de membranas Tillotson DG-10HS. Tillotson HS	DG-10HS
3	12 31088	Juego de membranas Tillotson DG-11HS. Tillotson HS	DG-11HS
4	12 31089	Juego de membranas Tillotson DG-1HK	DG-1HK
5	12 31054	Kit de reparación completo carburador Tillotson	RK-26HS
6	12 31055	Kit de reparación completo carburador compatible con Stihl TS400	RK-28HS
7	12 31003	Kit de reparación completo carburador Tillotson HU-83 RK-14HU	RK-14HU
8	12 31004	Kit de reparación completo carburador Tillotson HS-205 RK-23HS	RK-23HS
9	12 31090	Kit de reparación completo carburador RK-19HU. Dolmar 111/115	RK-19HU
10	12 31096	Kit de reparación completo carburador Tillotson RK-1HE	RK-1HE
11	12 31092	Kit de reparación completo carburador Tillotson RK-33HK. Stihl 034/038	RK-33HK

KITS DE REPARACIÓN CARBURADORES (Walbro)

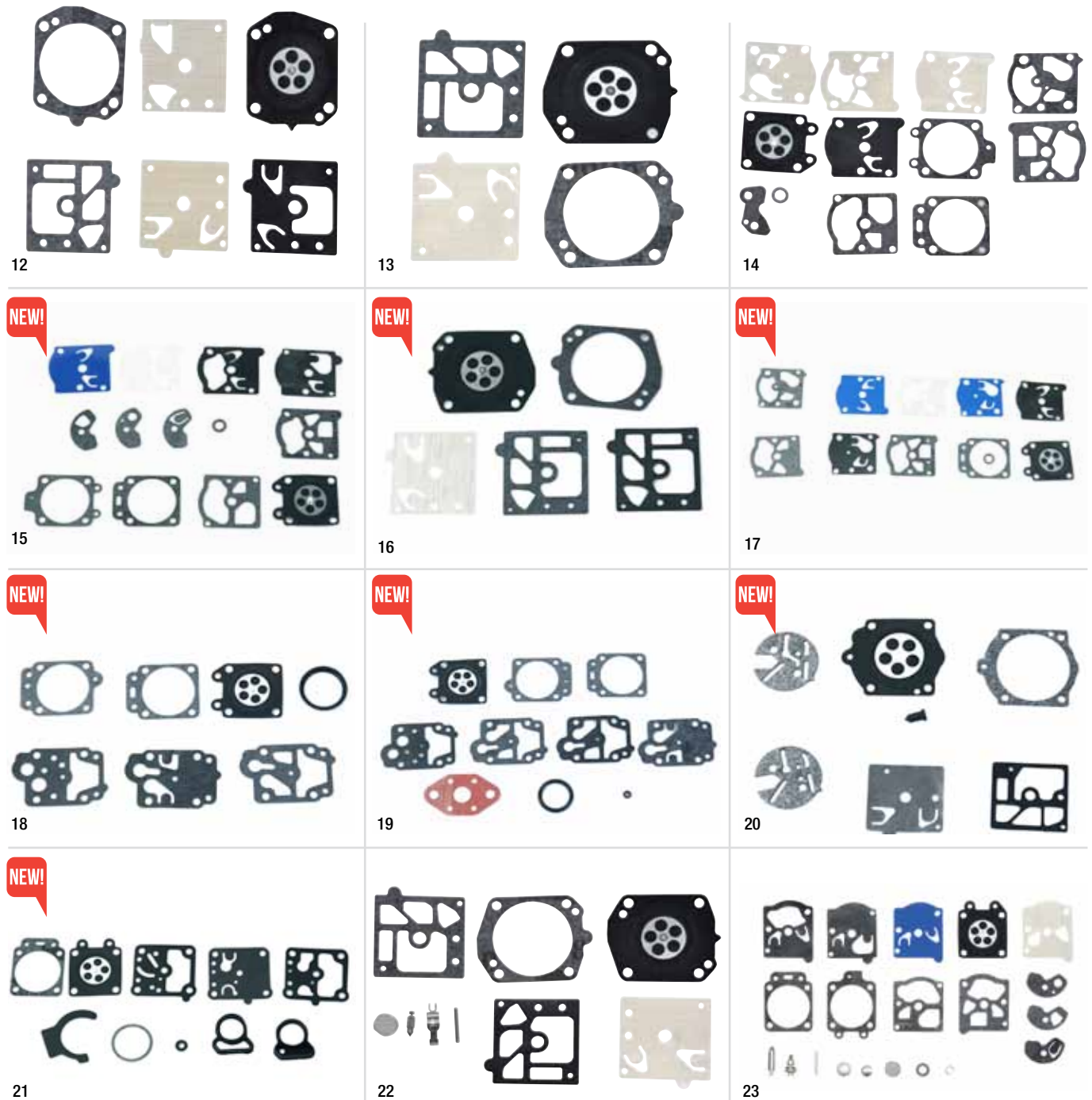

Nº	Referencia	Descripción	Ref. original
12	12 31005	Juego de membranas Walbro HDA. D20HDA	D20-HDA
13	12 31006	Juego de membranas Walbro HDA. D22HDA	D22-HDA
14	12 31010	Juego de membranas Walbro WT	D20-WAT
15	12 31007	Juego de membranas Walbro D10-WAT. Walbro WT	D10-WAT
16	12 31008	Juego de membranas Walbro D10-HD. Walbro HD	D10-HD
17	12 31009	Juego de membranas Walbro D22-WAT. Walbro WT 631/640	D22-WAT
18	12 31056	Juego de membranas Walbro WYJ	D20-WYJ
19	12 31057	Juego de membranas Walbro WYL-160A/133A	D11-WYL
20	12 31079	Juego de membranas Walbro D10-HDC	D10-HDC
21	12 31080	Juego de membranas Walbro D10-WZ	D10-WZ
22	12 31011	Kit de reparación completo carburador. Adaptable referencia K10-HD	K10-HD
23	12 31012	Kit de reparación completo carburador Walbro WAT	K10 -WAT

Las referencias o alusiones a otras marcas hechas en el catálogo sólo son indicativas y sirven para la comprobación de nuestros productos. Suministramos SÓLO PIEZAS NO ORIGINALES.

KITS DE REPARACIÓN CARBURADORES (Walbro)



Nº	Referencia	Descripción	Ref. original
24	12 31013	Kit de reparación completo carburador Walbro WJ	K15-WJ
25	12 31014	Kit de reparación completo carburador Walbro WAT	K20-WAT
26	12 31015	Kit de reparación completo carburador Walbro WAT. Adaptable a K22-WAT	K22-WAT
27	12 31016	Kit de reparación completo carburador Walbro WAT. Adaptable a K26-WAT; K11-WAT	K26-WAT
28	12 31017	Kit de reparación completo carburador Walbro K11-WB. Walbro WB	K11-WB
29	12 31018	Kit de reparación completo carburador Walbro K10-SDC. Walbro SDC	K10-SDC
30	12 31019	Kit de reparación completo carburador Walbro K22-HDA. Walbro HDA	K22-HDA
31	12 31020	Kit de reparación completo carburador Walbro K20-HDA. Walbro HDA	K20-HDA
32	12 31081	Kit de reparación completo carburador Walbro K10-HDB	K10-HDB
33	12 31082	Kit de reparación completo carburador Walbro K10-HDC	K10-HDC
34	12 31083	Kit de reparación completo carburador Walbro K10-WY	K10-WY
35	12 31084	Kit de reparación completo carburador Walbro K20-WYK. Reemplazada por K13-WYK	K20-WYK

KITS DE REPARACIÓN CARBURADORES (Walbro)



36

Nº Referencia	Descripción	Ref. original
36 12 31085	Kit de reparación completo carburador Walbro K10-WZ	K10-WZ

Linea AZUL

KITS DE REPARACIÓN CARBURADORES (Zama)



37



38



39



40



41



42

Nº Referencia	Descripción	Ref. original
37 12 31062	Juego de membranas Zama GND-1	GND-1
38 12 31063	Juego de membranas Zama GND-2	GND-2
39 12 31064	Juego de membranas Zama GND-4	GND-4
40 12 31065	Juego de membranas Zama GND-6	GND-6
41 12 31023	Juego de membranas Zama GND-7. C1S-S3. Stihl FS220	GND-7
42 12 31066	Juego de membranas Zama GND-8	GND-8

Linea AZUL

Las referencias o alusiones a otras marcas hechas en el catálogo sólo son indicativas y sirven para la comprobación de nuestros productos. Suministramos SÓLO PIEZAS NO ORIGINALES.

KITS DE REPARACIÓN CARBURADORES (Zama)

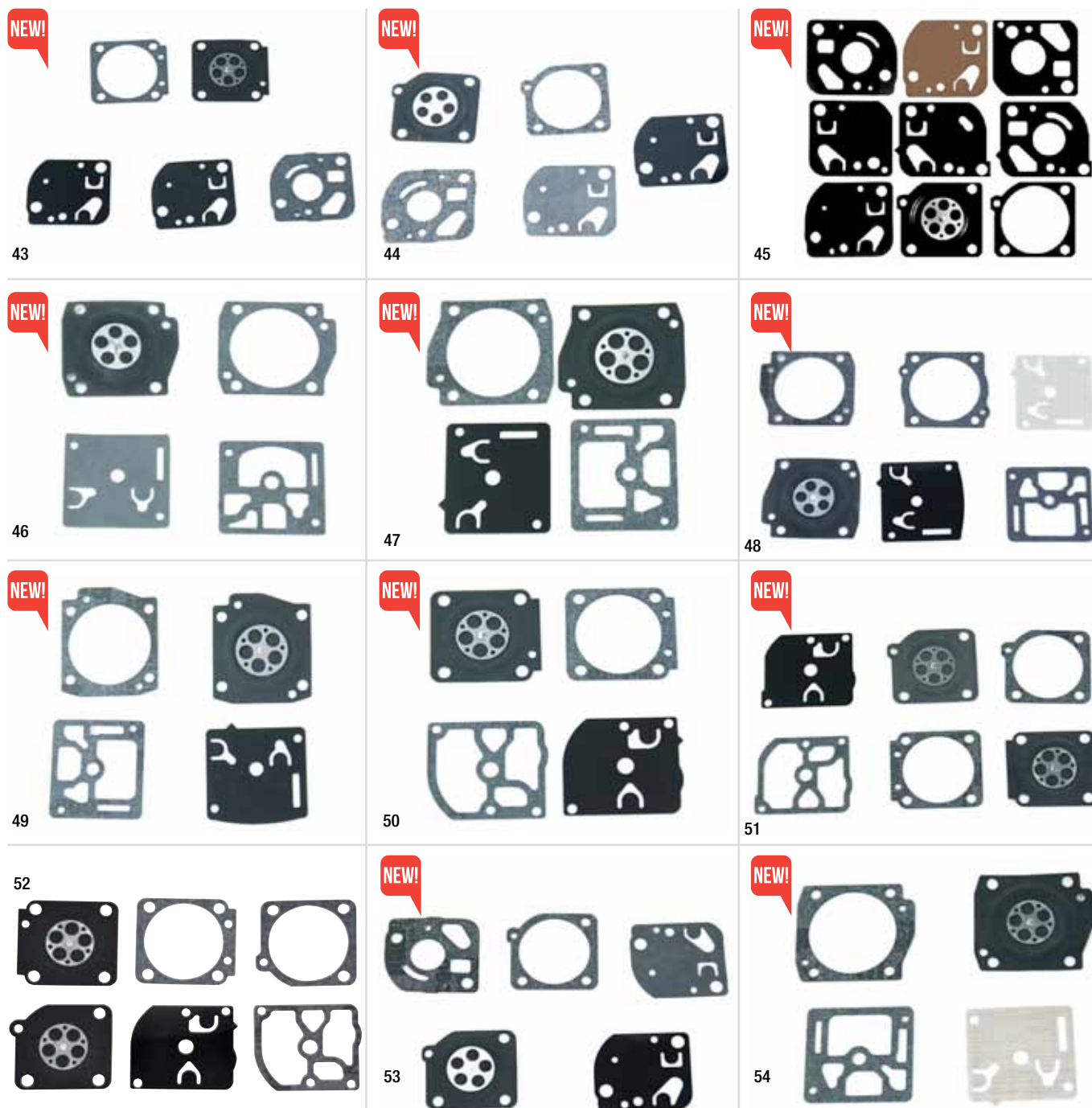

Nº	Referencia	Descripción	Ref. original
43	12 31024	Juego de membranas Zama GND-12	GND-12
44	12 31067	Juego de membranas Zama GND-17	GND-17
45	12 31068	Juego de membranas Zama GND-18	GND-18
46	12 31069	Juego de membranas Zama GND-19. Echo Cs 4100/4400/4600	GND-19
47	12 31025	Juego de membranas Zama GND-21. C3A-S4A. Stihl 034	GND-21
48	12 31070	Juego de membranas Zama GND-24	GND-24
49	12 31026	Juego de membranas Zama GND-25. C3M-S5C. Stihl 044	GND-25
50	12 31027	Juego de membranas Zama GND-28. C1Q-SK. Stihl FS75/85	GND-28
51	12 31028	Juego de membranas Zama GND-33. C1Q-EL1 (C1Q-S57A)	GND-33
52	12 31029	Juego de membranas Zama C1Q-EL12	GND-39
53	12 31071	Juego de membranas Zama GND-41	GND-41
54	12 31030	Juego de membranas Zama GND-54. C3-EL15-18	GND-54

KITS DE REPARACIÓN CARBURADORES (Zama)

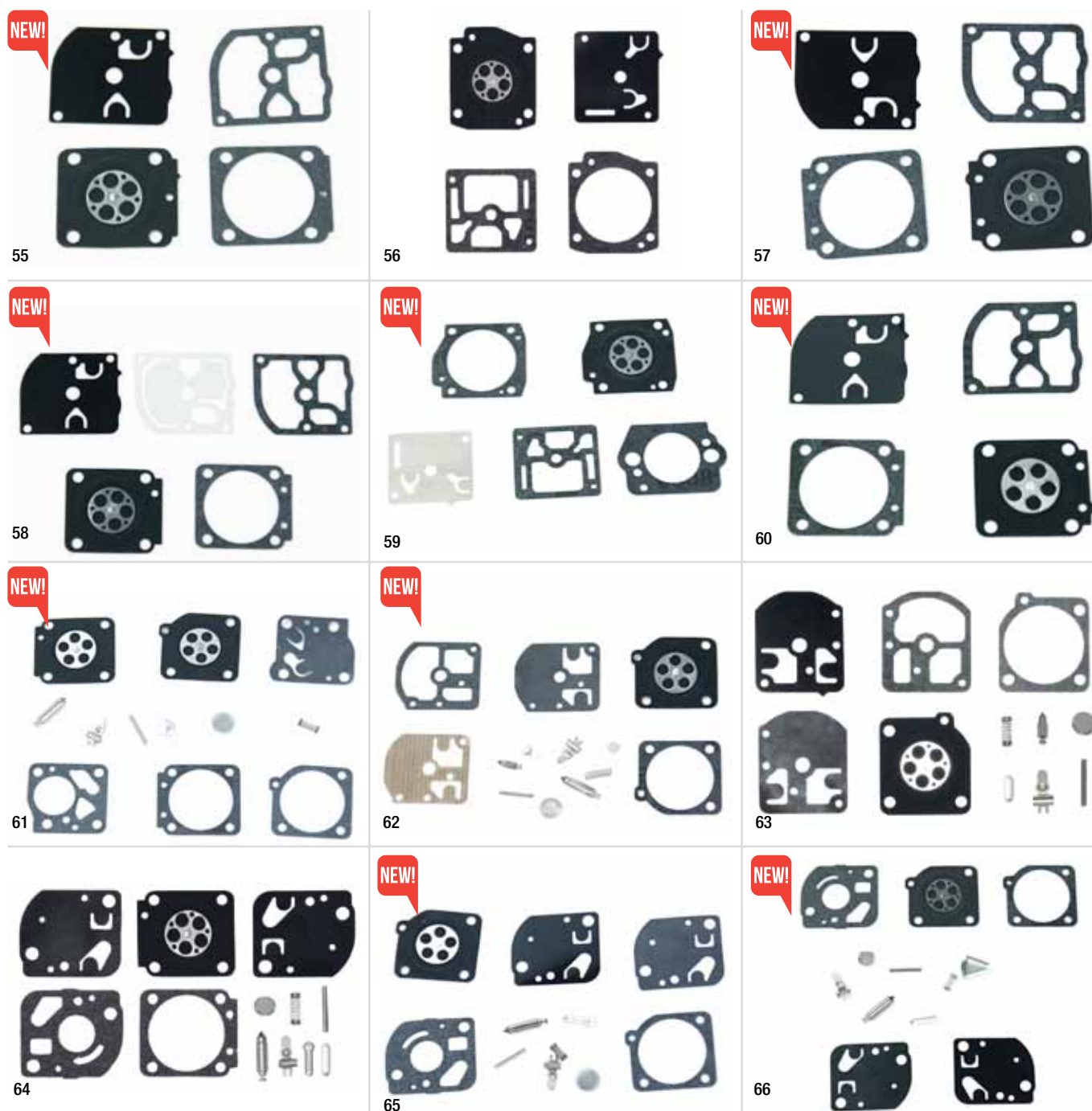

Nº	Referencia	Descripción	Ref. original
55	12 31031	Juego de membranas Zama GND-56. C1Q-S71/C1Q-S694	GND-56
56	12 31032	Juego de membranas Zama C3-EL18B HU 340/350	GND-65
57	12 31033	Juego de membranas Zama GND-70. C1M-W26	GND-70
58	12 31034	Juego de membranas Zama GND-71. C1M-EL28	GND-71
59	12 31035	Juego de membranas Zama GND-73. C3-EL29	GND-73
60	12 31072	Juego de membranas Zama GND-81	GND-81
61	12 31073	Kit de reparación completo Zama RB-1. McCulloch 300/310/510	RB-1
62	12 31074	Kit de reparación completo Zama RB-11. Stihl 09/010/011/012	RB-11
63	12 31036	Kit de reparación completo carburador Zama C1S-S3/C1S-SK1	RB-13
64	12 31037	Kit de reparación completo carburador Zama C1U-DM4A Makita RB-20	RB-20
65	12 31075	Kit de reparación completo carburador Zama RB-21.	RB-21
66	12 31038	Kit de reparación completo carburador Zama RB-27. C1U-K45	RB-27

Las referencias o alusiones a otras marcas hechas en el catálogo sólo son indicativas y sirven para la comprobación de nuestros productos. Suministramos SÓLO PIEZAS NO ORIGINALES.

KITS DE REPARACIÓN CARBURADORES (Zama)



Nº	Referencia	Descripción	Ref. original
67	12 31076	Kit de reparación completo carburador Zama RB-28	RB-28
68	12 31039	Kit de reparación completo carburador Zama C3A-S4A Stihl 034	RB-31
69	12 31040	Kit de reparación completo carburador Zama RB-35. C3M-FJ Robin	RB-35
70	12 31041	Kit de reparación completo carburador Zama C3M	RB-36
71	12 31077	Kit de reparación completo carburador Zama RB-38	RB-38
72	12 31042	Kit de reparación completo Zama RB-40. C1Q-S35A Stihl FS106	RB-40
73	12 31043	Kit de reparación completo carburador Zama C1Q	RB-41
74	12 31044	Kit de reparación completo carburador Zama C1Q-EL1	RB-45
75	12 31045	Kit de reparación completo carburador Zama RB-50. C1Q-S11G Stihl 021	RB-50
76	12 31046	Kit de reparación completo carburador Zama C1Q	RB-60
77	12 31078	Kit de reparación completo carburador Zama RB-63	RB-63
78	12 31047	Kit de reparación completo carburador Zama RB-66. C1Q-S Stihl FS75	RB-66

KITS DE REPARACIÓN CARBURADORES (Zama)



Nº Referencia	Descripción	Ref. original
79 12 31048	Kit de reparación completo Zama RB-69. C1Q-EL12. Husqvarna 325R	RB-69
80 12 31049	Kit de reparación completo Zama RB-72. C1Q-DM9B. Dolmar P34	RB-72
81 12 31050	Kit de reparación completo Zama RB-89. C1Q-S82 Stihl HS75, FS55,120,200,250,300,350	RB-89
82 12 31051	Kit de reparación completo Zama RB-95. C3-EL17. Husqvarna 351/353	RB-95
83 12 31052	Kit de reparación completo Zama RB-99. C1Q-S82. Stihl FS120	RB-99
84 12 31053	Kit de reparación completo Zama RB-100. C1Q-S71/C1Q-S69A	RB-100

Línea AZUL

PUÑOS DE ARRANQUE (compatible con Honda)



Nº Referencia	Descripción	Ref. original
1 12 23006	Puño de arranque compatible con Honda serie G y GX	28461-ZH8-003

Línea AZUL

PUÑOS DE ARRANQUE (compatible con Husqvarna)



2

Nº	Referencia	Descripción	Ref. original
2	12 23007	Tirador de arranque compatible con todos los modelos Husqvarna	503 54 39-01

Línea AZUL

PUÑOS DE ARRANQUE (compatible con Stihl)



3



4

5

Nº	Referencia	Descripción	Ref. original
3	12 23008	Tirador de arranque compatible con todo los modelos Stihl	1121 195 3400
4	12 23009	Tirador compatible con Stihl con cuerda de arranque de 3,5 mm	1113 195 8200
5	12 23010	Tirador compatible con Stihl con cuerda de arranque de 4 mm	1113 195 8200

Línea AZUL

PUÑOS DE ARRANQUE (Universal)



6

Nº	Referencia	Descripción	Ref. original
6	12 23011	Puño de arranque universal	

RODAMIENTOS (Gama económica)



1

Nº	Referencia	Descripción	Ref. original
1	12 43001	Rodamiento línea básica 608.2RS.B (8x22x7)	608.2RS.B
	12 43002	Rodamiento línea básica 609.2RS.B (9x24x7)	609.2RS.B
	12 43003	Rodamiento línea básica 629.2RS.B (9x26x8)	629.2RS.B
	12 43004	Rodamiento línea básica 6000.2RS.B (10x26x8)	6000.2RS.B
	12 43005	Rodamiento línea básica 6001.2RSB (12x28x8)	6001.2RS.B
	12 43006	Rodamiento línea básica 6002.2RS.B (15x32x9)	6002.2RS.B
	12 43007	Rodamiento línea básica 6003.2RS.B (17x35x10)	6003.2RS.B
	12 43008	Rodamiento línea básica 6004.2RS.B (20x42x12)	6004.2RS.B
	12 43009	Rodamiento línea básica 6005.2RS.B (25x47x12)	6005.2RS.B
	12 43010	Rodamiento línea básica 6006.2RS.B (30x55x13)	6006.2RS.B
	12 43011	Rodamiento línea básica 6007.2RS.B (35x62x14)	6007.2RS.B
	12 43012	Rodamiento línea básica 6008.2RS.B (40x68x15)	6008.2RS.B
	12 43013	Rodamiento línea básica 6009.2RS.B (45x75x16)	6009.2RS.B
	12 43014	Rodamiento línea básica 6010.2RS.B (50x80x16)	6010.2RS.B
	12 43015	Rodamiento línea básica 6200.2RS.B (10x30x9)	6200.2RS.B
	12 43016	Rodamiento línea básica 6201.2RS.B (12x32x10)	6201.2RS.B
	12 43017	Rodamiento línea básica 6202.2RS.B (15x35x11)	6202.2RS.B
	12 43018	Rodamiento línea básica 6203.2RS.B (17x40x12)	6203.2RS.B
	12 43019	Rodamiento línea básica 6204.2RS.B (20x47x14)	6204.2RS.B
	12 43020	Rodamiento línea básica 6205.2RS.B (25x52x15)	6205.2RS.B
	12 43021	Rodamiento línea básica 6206.2RS.B (30x62x16)	6206.2RS.B
	12 43022	Rodamiento línea básica 6300.2RS.B (10x35x11)	6300.2RS.B
	12 43023	Rodamiento línea básica 6301.2RS.B (12x37x12)	6301.2RS.B
	12 43024	Rodamiento línea básica 6302.2RS.B (15x42x13)	6302.2RS.B
	12 43025	Rodamiento línea básica 6303.2RS.B (17x47x14)	6303.2RS.B
	12 43026	Rodamiento línea básica 6304.2RS.B (20x52x15)	6304.2RS.B
	12 43027	Rodamiento línea básica 6305.2RS.B (25x62x17)	6305.2RS.B
	12 43028	Rodamiento línea básica 6306.2RS.B (30x72x19)	6306.2RS.B

Línea AZUL

Las referencias o alusiones a otras marcas hechas en el catálogo sólo son indicativas y sirven para la comprobación de nuestros productos. Suministramos SÓLO PIEZAS NO ORIGINALES.

RODAMIENTOS SKF (Máxima calidad)



1

Nº	Referencia	Descripción	Ref. original
1	12 43029	Rodamiento bolas SKF 608.2RSH/C3 (8x22x7)	608.2RSH/C3
	12 43030	Rodamiento bolas SKF 609.2RSH/C3 (9x24x7)	609.2RSH/C3
	12 43031	Rodamiento bolas SKF 629.2RSH/C3 (9x26x8)	629.2RSH/C3
	12 43032	Rodamiento bolas SKF 6000.2RSH/C3 (10x26x8)	6000.2RSH/C3
	12 43033	Rodamiento bolas SKF 6001.2RSH/C3 (12x28x8)	6001.2RSH/C3
	12 43034	Rodamiento bolas SKF 6002.2RSH/C3 (15x32x9)	6002.2RSH/C3
	12 43035	Rodamiento bolas SKF 6003.2RSH/C3 (17x35x10)	6003.2RSH/C3
	12 43036	Rodamiento bolas SKF 6004.2RSH/C3 (20x42x12)	6004.2RSH/C3
	12 43037	Rodamiento bolas SKF 6005.2RSH/C3 (25x47x12)	6005.2RSH/C3
	12 43038	Rodamiento bolas SKF 6006.2RS1/C3 (30x55x13)	6006.2RS1/C3
	12 43039	Rodamiento bolas SKF 6007.2RS1/C3 (35x62x14)	6007.2RS1/C3
	12 43040	Rodamiento bolas SKF 6008.2RS1/C3 (40x68x15)	6008.2RS1/C3
	12 43041	Rodamiento bolas SKF 6009.2RS1/C3 (45x75x16)	6009.2RS1/C3
	12 43042	Rodamiento bolas SKF 6010.2RS1/C3 (50x80x16)	6010.2RS1/C3
	12 43043	Rodamiento bolas SKF 6200.2RSH/C3 (10x30x9)	6200.2RSH/C3
	12 43044	Rodamiento bolas SKF 6201.2RSH/C3 (12x32x10)	6201.2RSH/C3
	12 43045	Rodamiento bolas SKF 6202.2RSH/C3 (15x35x11)	6202.2RSH/C3
	12 43046	Rodamiento bolas SKF 6203.2RSH/C3 (17x40x12)	6203.2RSH/C3
	12 43047	Rodamiento bolas SKF 6204.2RSH/C3 (20x47x14)	6204.2RSH/C3
	12 43048	Rodamiento bolas SKF 6205.2RSH/C3 (25x52x15)	6205.2RSH/C3
	12 43049	Rodamiento bolas SKF 6206.2RS1/C3 (30x62x16)	6206.2RS1/C3
	12 43050	Rodamiento bolas SKF 6300.2RSH/C3 (10x35x11)	6300.2RSH/C3
	12 43051	Rodamiento bolas SKF 6301.2RSH/C3 (12x37x12)	6301.2RSH/C3
	12 43052	Rodamiento bolas SKF 6302.2RSH/C3 (15x42x13)	6302.2RSH/C3
	12 43053	Rodamiento bolas SKF 6303.2RSH/C3 (17x47x14)	6303.2RSH/C3
	12 43054	Rodamiento bolas SKF 6304.2RSH/C3 (20x52x15)	6304.2RSH/C3
	12 43055	Rodamiento bolas SKF 6305.2RS1/C3 (25x62x17)	6305.2RS1/C3
	12 43056	Rodamiento bolas SKF 6306.2RS1/C3 (30x72x19)	6306.2RS1/C3

Línea
AZUL

RODAMIENTOS CON ALETAS



1

Nº	Referencia	Descripción	Compatible
1	12 43057	Rodamiento con aletas (28,58mmx11,12mm) 1-1/8 X7/16	Universal
	12 43058	Rodamiento con aletas (28,58mmx14,30mm) 9/16 X1-1/8	Universal
	12 43059	Rodamiento con aletas (28,58mmx12,70mm) 1-1/8X1/2	Universal
	12 43060	Rodamiento con aletas (34,92mmx12,70mm) 1-3/8X1/2	Universal
	12 43061	Rodamiento con aletas (34,92mmx15,87mm) 1-3/8X5/8	Universal
	12 43062	Rodamiento con aletas (34,92mmx19,05mm) 1-3/8X3/4	Snapper / Toro
	12 43063	Rodamiento con aletas (34,92mmx19,05mm) SN-110513,1-3/8X3/4	Universal / Snapper / Toro

Linea AZUL

SEGMENTOS (compatible con compatible con Husqvarna/Stihl/Kawasaki/...)

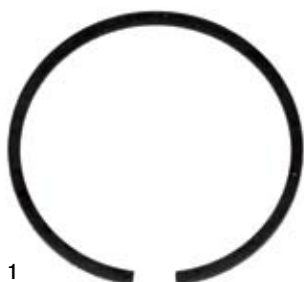

1

Nº	Referencia	Descripción
1	12 45010	Medida 37X1.2 (2PCS)
	12 45011	Medida 38X1.2 (2PCS)
	12 45012	Medida 40X1.2 (2PCS)
	12 45001	Medida 40X1.5 (1PCS)
	12 45008	Medida 42X1.5 (1PCS)
	12 45014	Medida 42X1.5 (2PCS)
	12 45013	Medida 42.5X1.2 (2PCS)
	12 45033	Zenoah 4500. 43X1.2 (2PCS)
	12 45015	Medida 44X1.2 (2PCS)
	12 45021	Medida 44X1.5 (2PCS)
	12 45016	Medida 44.7X1.2 (2PCS)
	12 45002	Medida 45X1.5 (1PCS)
	12 45003	Medida 46X1.5 (1PCS)
	12 45017	Medida 46X1.5 (2PCS)
	12 45032	Medida 47X1.2 (2PCS)
	12 45018	Medida 48X1.2 (2PCS)
	12 45004	Medida 48X1.5 (1PCS)
	12 45020	Medida 49X1.5 (2PCS)

SEGMENTOS (compatible con compatible con Husqvarna/Stihl/Kawasaki/...)



1

Nº	Referencia	Descripción
12	45022	Medida 50X1.2 (2PCS)
12	45005	Medida 50X1.5 (1PCS)
12	45023	Medida 52X1.2 (2PCS)
12	45007	Medida 52X1.5 (1PCS)
12	45019	Medida 52X1.5 (2PCS)
12	45024	Medida 54X1.2 (2PCS)
12	45006	Medida 54X1.5 (1PCS)
12	45027	Medida 56X1.2 (2PCS)
12	45031	Medida 56X1.5 (2PCS)
12	45028	Medida 58X1.5 (2PCS)

Línea
AZUL

TUBOS DE GASOLINA



1

Nº	Referencia	Descripción
1	12 28001	Tubo mezcla 2,5mm x 4,8 mm/ 7,5 m
	12 28002	Tubo mezcla 3,0 mm x 5,5 mm / 3,8m
	12 28003	Tubo mezcla 3,2mm x 6,0mm/7,5m
	12 28004	Tubo mezcla 5,0mm x 8,0mm/7,5m

Línea
AZUL



KURIA®

MOTOGARDEN, S.A.

C/ Eduardo Pondal, s/n
Poligono de Sigüeiro, Parcela 58
15688 Sigüeiro-Oroso (A Coruña)

Tel. +34 981 69 63 08
Fax. +34 981 69 08 78

motogarden@motogarden.com
www.motogarden.com

ACCESORIOS MOTOSIERRAS



KURID[®]

BAYGAR

ROLLOS CADENA (Carlton)



1

Nº	Referencia	Descripción	Paso	Nº Eslabones (rollo 100')	Tipo diente
1	22 N4CBL	Rollo cadena N4C-BL	3/8 PM 0,43 1,1mm	1632	Redondo
	22 N1CBL	Rollo cadena N1C-BL	3/8 BP 0,50 1,3mm	1632	Redondo
	22 K1CBL	Rollo cadena K1C-BL	325 0,50 1,3mm	1848	Redondo
	22 K2CBL	Rollo cadena K2C-BL	325 0,58 1,5mm	1848	Redondo
	22 K3CBL	Rollo cadena K3C-BL	325 0,63 1,6mm	1848	Redondo
	22 K1L	Rollo cadena K1L	325 0,50 1,3mm	1848	Cuadrado
	22 K2L	Rollo cadena K2L	325 0,58 1,5mm	1848	Cuadrado
	22 K3L	Rollo cadena K3L	325 0,63 1,6mm	1848	Cuadrado
	22 A1EP	Rollo cadena A1EP	3/8 0,50 1,3mm	1632	Redondo
	22 A2EP	Rollo cadena A2EP	3/8 0,58 1,5mm	1632	Redondo
	22 A3EP	Rollo cadena A3EP	3/8 0,63 1,6mm	1632	Redondo
	22 A1LM	Rollo cadena A1LM	3/8 0,50 1,3mm	1632	Cuadrado
	22 A2LM	Rollo cadena A2LM	3/8 0,58 1,5mm	1632	Cuadrado
	22 A3LM	Rollo cadena A3LM	3/8 0,63 1,6mm	1632	Cuadrado
	22 E1MCBL	Rollo cadena E1MCBL	1/4 0,50 1,3mm	2393	Redondo

Línea AZUL

REMACHES CADENA (Carlton)

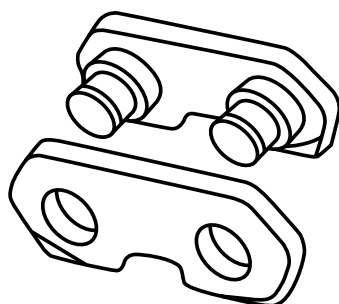

1

Nº	Referencia	Descripción
1	22 43011PK	Remaches cadena 3/8 bp (25u.)
	22 43002PK	Tapas remache cadena 3/8 bp (25u.)
	22 43008	Remaches cadena 325 (25u.)
	22 43009	Remache cadena 325 0,63
	22 43000	Tapas remache cadena 325 (25u.)
	22 43012	Remaches cadena 3/8 (25u.)
	22 43013	Remache cadena 3/8 0,63
	22 43003	Tapas remache cadena 3/8 (25u.)
	22 43015	Remache cadena 404 (25u.)
	22 43004	Tapas remache cadena 404 (25u.)
	22 43045	Remaches cadena 1/4 (25u.)

Línea AZUL

CADENAS CORTADAS (Carlton)



1

Nº	Referencia	Descripción	Paso	Nº Eslabones	Tipo diente
1	22 N1CBL040E	Cadena 3/8 bp 1,3mm 40E	3/8 BP 1,3mm 40E	40	Redondo
	22 N1CBL044E	Cadena 3/8 bp 1,3mm 44E	3/8 BP 1,3mm 44E	44	Redondo
	22 N1CBL045E	Cadena 3/8 bp 1,3mm 45E	3/8 BP 1,3mm 45E	45	Redondo
	22 N1CBL050E	Cadena 3/8 bp 1,3mm 50E	3/8 BP 1,3mm 50E	50	Redondo
	22 N1CBL052E	Cadena 3/8 bp 1,3mm 52E	3/8 BP 1,3mm 52E	52	Redondo
	22 N1CBL055E	Cadena 3/8 bp 1,3mm 55E	3/8 BP 1,3mm 55E	55	Redondo
	22 N1CBL056E	Cadena 3/8 bp 1,3mm 56E	3/8 BP 1,3mm 56E	56	Redondo
	22 N1CBL057E	Cadena 3/8 bp 1,3mm 57E	3/8 BP 1,3mm 57E	57	Redondo
	22 K1C064E	Cadena 325 0,50 1,3 mm 64 E	325 0,50 1,3 mm 64 E	64	Redondo
	22 K1CBL066E	Cadena 325 0,50 1,3 mm 66 E	325 0,50 1,3 mm 66 E	66	Redondo
	22 K1CBL072E	Cadena 325 0,50 1,3 mm 72 E	325 0,50 1,3 mm 72 E	72	Redondo
	22 K2CBL064E	Cadena 325 0,58 1,5mm 64E	325 0,58 1,5mm 64E	64	Redondo
	22 K2CBL066E	Cadena 325 0,58 1,5mm 66E	325 0,58 1,5mm 66E	66	Redondo
	22 K2C072E	Cadena 325 0,58 1,5mm 72E	325 0,58 1,5mm 72E	72	Redondo
	22 K3C067E	Cadena 325 0,63 1,6mm 67E	325 0,63 1,6mm 67E	67	Redondo
	22 K3CBL074E	Cadena 325 0,63 1,6mm 74E	325 0,63 1,6mm 74E	74	Redondo
	22 A2EP060E	Cadena 3/8 0,58 1,5mm 60E	3/8 0,58 1,5mm 60E	60	Redondo
	22 A2EP068E	Cadena 3/8 0,58 1,5mm 68E	3/8 0,58 1,5mm 68E	68	Redondo
	22 A2EP072E	Cadena 3/8 0,58 1,5mm 72E	3/8 0,58 1,5mm 72E	72	Redondo
	22 A3EP066E	Cadena 3/8 0,63 1,6mm 66E	3/8 0,63 1,6mm 66E	66	Redondo
	22 K1L064E	Cadena 325 0,50 1,5mm 64E	325 0,50 1,5mm 64E	64	Cuadrado
	22 K1L072E	Cadena 325 0,50 1,5mm 72E	325 0,50 1,5mm 72E	72	Cuadrado
	22 K2L064E	Cadena 325 0,58 1,5mm 64E	325 0,58 1,5mm 64E	64	Cuadrado
	22 K2L066E	Cadena 325 0,58 1,5mm 66E	325 0,58 1,5mm 66E	66	Cuadrado
	22 K2L072E	Cadena 325 0,58 1,5mm 72E	325 0,58 1,5mm 72E	72	Cuadrado
	22 A2LM060E	Cadena 3/8 0,58 1,5mm 60E	3/8 0,58 1,5mm 60E	60	Cuadrado
	22 A2LM068E	Cadena 3/8 0,58 1,5mm 68E	3/8 0,58 1,5mm 68E	68	Cuadrado
	22 A2LM072E	Cadena 3/8 0,58 1,5mm 72E	3/8 0,58 1,5mm 72E	72	Cuadrado
	22 A3LM066E	Cadena 3/8 0,63 1,6mm 66E	3/8 0,63 1,6mm 66E	66	Cuadrado
	22 E1MCBL060E	Cadena 1/4 0,50 1,3 mm 60E	1/4 0,50 1,3 mm 60E	60	Redondo

Línea AZUL

ESPADAS (Carlton)

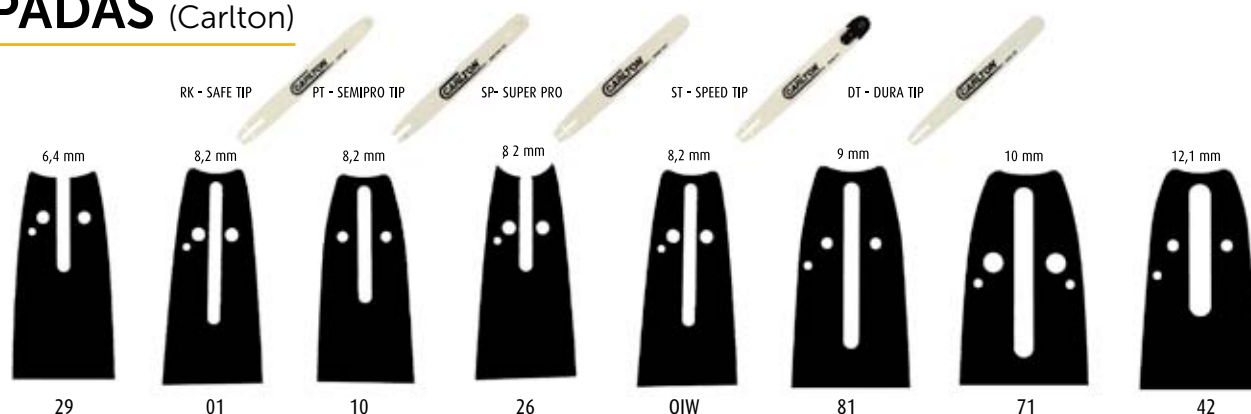

Nº	Referencia	Descripción	Paso	Nº Eslabones	Longitud
McCulloch					
29	22 1629N154RK	Espada carlton 16 3/8 LP	3/8 BP 0,50	54	16 40cm
Husqvarna-Jonsered-Partner-Solo, Etc					
01	22 1401N152PT	Espada carlton 3/8 BP 0,50 52E	3/8 BP 0,50	52	14 35cm
	22 1601N156PT	Espada carlton 3/8 BP 0,50 56E	3/8 BP 0,50	56	16 40cm
Alko-Dolmar-Echo-Tanaka, Etc					
10	22 1210N145RK	Espada carlton 3/8 BP 45E	3/8 BP 0,50	45	12 30cm
	22 1410N152PT	Espada carlton 3/8 BP 52E	3/8 BP 0,50	52	14 35cm
	22 1610N157PT	Espada carlton 3/8 BP 57E	3/8 BP 0,50	57	16 40cm
Oleomac-Efco-Stihl, Etc					
26	22 1226N144PT	Espada carlton 3/8 BP 44E	3/8 BP 0,50	44	12 30cm
	22 1426N150PT	Espada carlton 3/8 BP 0,50 50E	3/8 BP 0,50	50	14 35cm
	22 1626N155PT	Espada carlton 3/8 BP 55E	3/8 BP 0,50	55	16 40cm
	22 1626K362SP	Espada carlton 325 0,63 62E	325 0,63	62	16 40cm
	22 1826K368SP	Espada carlton 325 0,63 68E	325 0,63	68	18 45cm
Alpina-Husqvarna-Jonsered-Oleomac-Efco-Partner-Dolmar-Solo, Etc					
OIW	22 1501WK264SP	Espada carlton 15 325 64E	325 0,58	64	15 38cm
	22 1601WK266SP	Espada carlton 16 325 66E	325 0,58	66	16 40cm
	22 1801WK172SP	Espada carlton 18 325 72E	325 0,50	72	18 45cm
	22 1801WK272SP	Espada carlton 18 325 72E	325 0,58	72	18 45cm
	22 1801WA268SP	Espada carlton 18 3/8 68E	3/8 0,58	68	18 45cm
81	22 1681A260SP	Espada carlton 3/8 0,58 60E	3/8 0,58	60	16 40cm
	22 1681A260ST	Espada carlton 3/8 0,58 60E	3/8 0,58	60	16 40cm
	22 1681058DT	Espada carlton 3/8 16 solida	3/8 0,58	60	16 40cm
	22 1881A268SP	Espada carlton 18 3/8 68E	3/8 0,58	68	18 45cm
	22 1881A268ST	Espada carlton 3/8 18 puntera	3/8 0,58	68	18 45cm
	22 1881058DT	Espada carlton 3/8 18 solida	3/8 0,58	68	18 45cm
	22 2081A272SP	Espada carlton 3/8 0,58 72E	3/8 0,58	72	20 50cm
Oleomac-Folux-Jonsered-Topso					
71	22 1671A260SP	Espada carlton 3/8 0,58 60E	3/8 0,58	60	16 40cm
	22 1871A268SP	Espada carlton 3/8 0,58 68E	3/8 0,58	68	18 45cm
Stihl					
42	22 1642K367PT	Espada carlton 325 0,63 67E	325 0,63	67	16 40cm
	22 1642A360SP	Espada carlton 3/8 0,63 60E	3/8 0,63	60	16 40cm
	22 1842A366SP	Espada carlton 18 3/8	3/8 0,63	66	18 45cm
	22 1842A366ST	Espada carlton 3/8 18 puntera	3/8 0,63	66	18 45cm
	22 2042A372SP	Espada carlton 20 3/8	3/8 0,63	72	20 50cm
	22 2042063DT	Espada carlton 3/8 20 solida	3/8 0,63	72	20 50cm

Las referencias o alusiones a otras marcas hechas en el catálogo sólo son indicativas y sirven para la comprobación de nuestros productos. Suministramos SÓLO PIEZAS NO ORIGINALES.

PUNTERAS (Carlton)

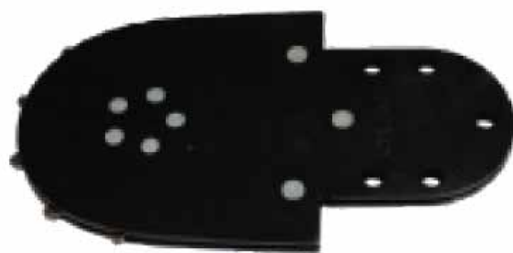

1



2

Nº	Referencia	Descripción
1	22 STA325	Punteras windsor 325
	22 STA375	Punteras windsor 3/8
2	22 PST325	Punteras tipo oregon 325
	22 PST375	Punteras tipo oregon 3/8
	22 PST404	Punteras tipo oregon 404

Línea AZUL

PUNTERAS (Kuril)



3



4



5

Nº	Referencia	Descripción
3	78 63001	Puntera 325
4	78 63002	Puntera 3/8
5	78 63003	Puntera 404

Línea AZUL

CORONAS PIÑONES (Carlton)



1

Nº	Referencia	Descripción
1	22 SR811891	Corona piñon 325 8 dientes
	22 SR718720	Corona piñon 3/8 7 dientes (pequeña)
	22 SR768210	Corona piñon 3/8 7 dientes
	22 SR822273	Corona piñon 3/8 8 dientes
	22 SR722270	Corona piñon 404 7 dientes

Ver también coronas Kuril en el epígrafe de recambios de motosierra. Página 43

Línea AZUL

PIÑONES CADENAS (Carlton)



Nº	Referencia	Descripción	Ref. original
1	22 5106656X	Piñon cadena 325X7 Husq.36/41/136/141/137/142/235/236/240 Jonsered 2035-2036-2040 Partner 365-405	530 06 93 42
2	22 635641X	Piñon cadena 325X7 Rec. Husq.40/45 Jonsered 2041-2045-2050-2063	503 15 98 02
2	22 6108215X	Piñon cadena 325x7 Rec. Husq.346/351/353/345 Jonsered 2145-2149-2159-2141-2159-2141-2150 etc	503 98 00 71
1	22 629175X	Piñon cadena 325x7 Rec. Husq.50/51/55/154/254/262 Jonsered 490-590 Partner 500-545 etc	503 74 54 01
1	22 5108308X	Piñon cadena 325x7 Fijo Husq. 340/350/345/445/450 Jonsered CS2245-CS2250	578 09 79 01
2	22 6102469	Piñon cadena 3/8 X 7 Rec. Husq.61/66/162/266/268/272/372 Jonsered 625/630/670	503 65 09 01
1	22 532057	Piñon cadena 3/8 X 7 Fijo Husq.61/66/162/266/268/272/372 Jonsered 625/630/670	501 83 15 04
2	22 6105772X	Piñon cadena 3/8 X 7 Rec.Husq.365/371/372/570/575/576 Jonsered 2165	503 86 17 03
2	22 628094X	Piñon cadena 3/8 X 7 Rec. Husq. 281/285/288/394/395 Jonsered 2100	503 62 59 03
2	22 6100961X	Piñon cadena 325X7 Rec. Stihl 017/018/019/021/023/ MS170-180-210-230-190-210-250	1123 007 1031
1	22 5100962X	Piñon cadena 3/8 X 6 Rec. Stihl 017/018/019/021/023/25/ MS170-180-190- 210-230-190-210-250	1123 640 2073
2	22 6100791X	Piñon cadena 325X7 Rec. Stihl 024/026/MS240/260/260 PRO/MS270	
2	22 634162X	Piñon cadena 3/8 X 7 Rec. Stihl 029/034/036/039/MS290/310/360/390	
3	22 21276	Rodamiento piñon para ref. 628094X	
3	22 37325	Rodamiento piñon para ref. 5106656X, 6100961X, 5100962X, 6100791X	
3	22 11893	Rodamiento piñon para ref. 629175X, 5108308X, 6108215X, 635641X	
3	22 11999	Rodamiento piñon para 6102469, 532057	
3	22 37501	Rodamiento piñon para 6105772X	

Linea AZUL

Las referencias o alusiones a otras marcas hechas en el catálogo sólo son indicativas y sirven para la comprobación de nuestros productos. Suministramos SÓLO PIEZAS NO ORIGINALES.

KIT CARVING



Nº	Referencia	Descripción
1	22 631825AP8	Kit carving

Linea AZUL

ACCESORIOS MOTOSIERRA VARIOS

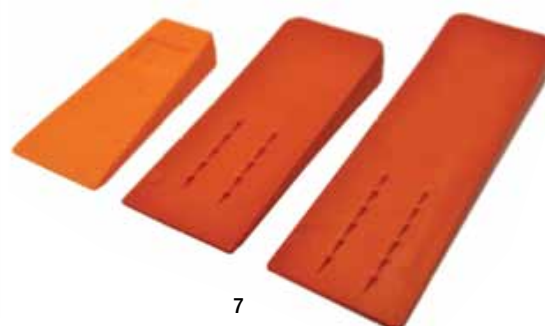

Nº	Referencia	Descripción
1	78 6399BAR45	Funda espada (45cm)
2	22 21C1840	Carlton Caja limas 5/32 4mm (12 unidades)
	22 21C1848	Carlton Caja limas 3/16 4,8mm (12 unidades)
	22 21C1852	Carlton Caja limas 13/64 5,2mm (12 unidades)
	22 21C0855	Carlton Caja limas 7/32 5,5mm (12 unidades)
	22 20C0616	Carlton Caja lima plana
3	78 159927061	Limas kuril. Lima redonda 8 x 5/32 4,0 mm (Blister 3 unidades)
	78 159927062	Limas kuril. Lima redonda 8 x 13/64 5,2 mm (Blister 3 unidades)
	78 159927063	Limas kuril. Lima redonda 8 x 3/16 4,8 mm (Blister 3 unidades)
	78 159927064	Limas kuril. Lima redonda 8 x 7/32 5,5 mm (Blister 3 unidades)
4	22 SPCA8Y	Bujia 2 tiempos (Motosierra/Desbrozadora)
	44 SPLR19A	Bujia 4 tiempos (BRIGGS STRATTON)
5	28 15C1532	Piedra afiladora 4mm (3 unidades)
	28 15C1316	Piedra afiladora 4,8mm (3 unidades)
	28 15C1732	Piedra afiladora 2 unidades 13/64
6	78 13031	Engrasador espadas Kuril
7	78 1055903A	Cuña 14cm
	78 1055901A	Cuña 19cm
	78 1055904A	Cuña 27cm

ACCESORIOS MOTOSIERRA VARIOS

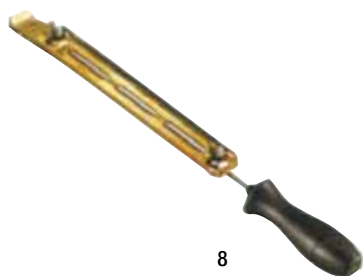

8



9



10



13



12



11



14

NEW!



15



16

NEW!



17

Nº	Referencia	Descripción
8	22 1011966	Portalimas con lima 4,8mm (admite limas hasta 5,5mm)
9	22 1013006	Mango de lima 30° y 35°
10	78 1599X10047	Mango de lima profesional de plástico con seguro
	22 K00204006	Disco afiladora profesional 145x22x4,7
	78 99142232	Disco afiladora 145x22,3x3,2
	78 99142247	Disco afiladora 145x22,3x4,7
11	22 1020961	Rompedor cadena
12	22 1025950	Remachador cadena
13	28 1147981	Afiladora manual.
14	78 13032	Afiladora manual. KURIL
15	22 1020070	Yunque rompedor
16	22 1020033E	Punzon rompedor
17	78 13033	Soporte de tocón

Línea AZUL

AFILADORAS ELÉCTRICAS



1



2

Nº	Referencia	Descripción
1	22 11509004	Afiladora profesional automática 214w 2800 rpm
2	78 1399FY230SA	Afiladora electrica. Voltaje 230V-230w. Revoluciones máximas: 3.000 rpm

Línea AZUL

SOPORTE PARA TRONCOS



1



2

Nº	Referencia	Descripción
1	78 13034	Soporte para troncos
2	78 13035	Soporte para troncos profesional



KURIA®

MOTOGARDEN, S.A.

C/ Eduardo Pondal, s/n
Poligono de Sigüeiro, Parcela 58
15688 Sigüeiro-Oroso (A Coruña)

Tel. +34 981 69 63 08
Fax. +34 981 69 08 78

motogarden@motogarden.com
www.motogarden.com

RECAMBIOS MOTOSIERRAS

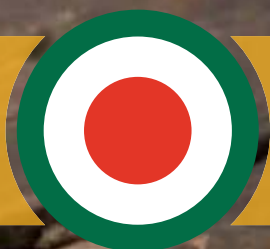

KURID®

BAYGAR

AMORTIGUADORES (compatible con Dolmar)



Nº	Referencia	Compatible con modelos	Ref. original
1	12 34001	109/110/115/Makita DCS 430, DCS 520, DCS 4300	965 403 280
2	12 34002	PS420/5000/6400/7300/7900	038 114 151
3	12 34003	PS5000	181 114 301

Línea AZUL

AMORTIGUADORES (compatible con Husqvarna)



Nº	Referencia	Compatible con modelos	Ref. original
4	12 34004	61/66/266/268/272/625/670 (Estándar)	501 77 34 01
5	12 34005	61/66/266/268/272/ 625/670 (Estándar)	501 77 35 01
6	12 34006	36/41/61/136/137/141/242/268/266/272. Jonsered 625/670. Reforzado	501 62 87 01
7	12 34007	50/51/55	501 76 39 02
8	12 34008	345/570/575/576 (Goma soporte carburador)	503 86 93 01
9	12 34009	281/288	501 81 47 01
10	12 34010	365/ 371/ 372. Jonsered 2071/ 2171/ 2172	503 89 56 01
11	12 34011	365/ 371/ 372. Jonsered 2071/ 2171/ 2172	503 63 76 01/02
12	12 34012	365/ 371/ 372. Jonsered 2071/ 2171/ 2172	503 63 75 02

AMORTIGUADORES (compatible con Husqvarna)



Nº	Referencia	Compatible con modelos	Ref. original
13	12 34013	385/390/394/395. Jonsered CS 2186/2188	503 52 87 02
14	12 34014	340/345/350/351/346/353/357/359/455/460 Jonsered 2145/ 2147/ 2156/ 2159	503 85 41 01
15	12 34015	235/ 235E/ 240/ 240E/236. Jonsered 2234/ 2238	545 03 39 01
16	12 34016	235/ 235E/ 240/ 240E/236. Jonsered 2234/ 2238	545 06 31 01
17	12 34017	235 /235E/ 240/236/240E. Jonsered 2234/ 2238	545 03 38 01
18	12 34018	445/450. Jonsered 2245/2250	544 10 12 01
19	12 34019	445/450/445E/450E. Jonsered 2255	537 30 46 01

Línea AZUL

AMORTIGUADORES (compatible con Oleo-Mac)



20

Nº	Referencia	Compatible con modelos	Ref. original
20	12 34020	938/941/942/946/951-Efco 138/141/142/146/151	50070024

Línea AZUL

AMORTIGUADORES (compatible con Stihl)



Nº	Referencia	Compatible con modelos	Ref. original
21	12 34023	024/026/028/034/036/038/044/046/064/066/MS461/MS650/TS400/TS460 (Tapón amortiguador)	1125 791 7306
22	12 34024	034/MS360/MS440/MS460/MS461/MS640/MS650/MS660 (Ø=28,55; D=32,79; H=26,58)	1125 790 9904
23	12 34025	038/084/088/TS400 (Tapón amortiguador)	1119 791 7306
24	12 34026	024/026/028/038/MS260	1121 790 9909
25	12 34027	024/026/038/MS260/MS880/TS400	1121 790 9912
26	12 34028	021/023/025/029/039/MS210/MS230/MS250/MS290/MS310/MS390	1123 791 2805
27	12 34029	021/023/025/029/039/MS210/MS230/MS250/MS290/MS310/MS390 (Ø=24,92; D=25,71; H=32,50)	1123 790 9900
28	12 34030	044/046/MS440/MS460/640	1122 790 9905
29	12 34031	029/039/MS290/MS390	1127 790 9900
30	12 34032	070/090	1106 791 9500
31	12 34033	171/181/211	0000 791 3104
32	12 34034	171/181/211	0000 791 3103

Las referencias o alusiones a otras marcas hechas en el catálogo sólo son indicativas y sirven para la comprobación de nuestros productos. Suministramos SÓLO PIEZAS NO ORIGINALES.

AMORTIGUADORES (compatible con Stihl)



33



34



35



36

NEW!



37

NEW!



38

NEW!



39

NEW!



40

NEW!



41

NEW!



42

NEW!



43

NEW!



44

Nº	Referencia	Compatible con modelos	Ref. original
33	12 34035	MS341/MS361	1135 790 9902
34	12 34036	MS341/MS361	1135 791 3100
35	12 34037	028/038	1118 790 9930
36	12 34038	064/066/MS640/MS660/TS800	1122 790 9900
37	12 34039	MS170/180/190E/270/280 (Ø=21,56; D=24,99; H=30,59)	1123 791 2800 / 1132 791 2800
38	12 34042	028/038 (trasero) (Ø=24,88; D=28,52; H=26)	1121 790 9912
39	12 34046	038 (Ø=23,90; D=33,25; H=27,21)	1121 790 9909
40	12 34047	044/046/MS440/MS460 (Ø=18; D=32,77; H=21,81)	1128 790 9905
41	12 34048	064-066 (Ø=19,40; D=30,83; H=15,14)	1122-790-9920
42	12 34043	341-361-361C (Ø=18; H=77)	1135 790 8300
43	12 34044	018-MS180 (Tapón amortiguador)	1123 791 7300
44	12 34045	024-026-038-MS240-MS260 (Tapón amortiguador)	1119 791 7305

ARANDELAS Y PRESILLAS (compatible con Husqvarna/Jonsered/Stihl)



1



2



3



4

Nº	Referencia	Compatible con modelos	Ref. original
1	12 59001	Arandela compatible con todos los Husqvarna 365/371/372/385/390/575/576/570	503 75 24 01
2	12 59002	Presilla compatible con todos los Husqvarna 365/371/372/385/390/575/576/570	503 27 21 01
3	12 59003	Arandela compatible con Stihl 025/026/066/MS260/MS660	0000 958 1032
4	12 59004	Presilla compatible con Stihl 026/066/MS260/MS660	9460 624 0801

Línea AZUL

ASAS (compatible con Husqvarna)



1



2



3

NEW!



4

NEW!



5

Nº	Referencia	Compatible con modelos	Ref. original
1	12 53001	365/371/372	503 62 67 71
2	12 53002	288/281	501 80 75 05
3	12 53003	61/162/266/268/272	501 53 45 03
4	12 53004	137/142	530 05 99 61
5	12 53006	340/345/346/350/351/353	537 30 17 01 Ref. Antigua: 503 85 37 01

Línea AZUL

ASAS (compatible con Stihl)



Nº	Referencia	Compatible con modelos	Ref. original
6	12 53007	038/MS380/MS381	1119 790 1700
7	12 53008	044/MS440/046/MS460	1128 790 1753
8	12 53009	024/026/MS260	1121 790 1714
9	12 53010	066/MS660	1122 790 1750
10	12 53011	MS180	1130 791 4901
11	12 53012	MS250	1123 791 1700

Linea AZUL

BOBINAS DE ENCENDIDO (compatible con Oleo-Mac)



Nº	Referencia	Compatible con modelos	Ref. original
6	12 16006	936/ 940/940C	500 50013

Linea AZUL

BOBINAS DE ENCENDIDO (compatible con Partner)



Nº	Referencia	Compatible con modelos	Ref. original
7	12 16007	350/351/370 Jonsered 2035/ 2137	530 05 22 77

BOBINAS DE ENCENDIDO (compatible con Husqvarna)



Nº	Referencia	Compatible con modelos	Ref. original
1	12 16001	50/51/55/154/254/262/257/240R/245R/250R/252R. Jonsered RS44/ GR41/GR50	544 01 83 01 (Reemplaza 503 90 12 01)
2	12 16002	61/268/272. Jonsered 2054 / 2055	544 01 84 01
3	12 16003	335/345/359/365/372. Jonsered 2065/2071/2163/ 2165/ 2171	510 11 57 01. Ref.Antigua: 544 04 71 01/ 537 16 22 04
4	12 16004	340/ 345/ 346XP/ 350/ 357XP/ 359/ 455e Rancher. Jonsered 2139/ 2145/ 2147/ 2152/ 2156/ 2159/ 2255	544 04 70 01
5	12 16005	137/142	545 06 39 01

Línea AZUL

BOBINAS DE ENCENDIDO (compatible con Stihl)



Nº	Referencia	Compatible con modelos	Ref. original
8	12 16008	026/029/034/036/044/046/048/MS260/MS290/ MS340/MS380/MS390/MS440	0000 400 1300
9	12 16009	017/018/MS170/MS180	1130 400 1300
10	12 16010	021/023/025/MS200/MS210/MS230/MS250	0000 400 1306

Línea AZUL

BOMBAS DE ENGRASE (compatible con Husqvarna/Jonsered)

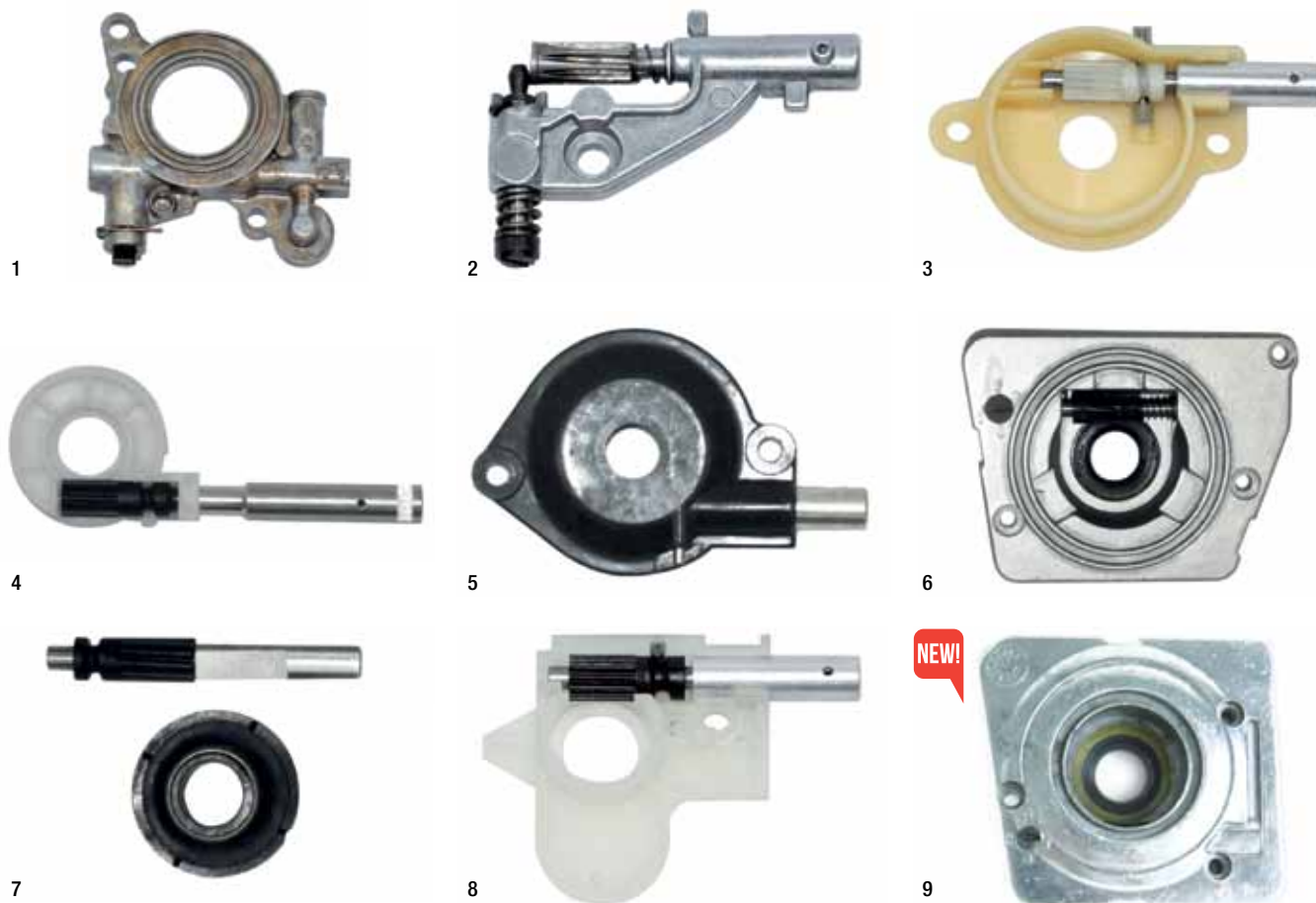

Nº	Referencia	Compatible con modelos	Ref. original
1	12 47001	371/365/ 372/ 570/ 575. Jonsered 2063/ 2065/ 2071/ 2163/ 2165/ 2166/ 2171/ 2172	503 52 13 03
2	12 47002	T540XP/346XP/350/353. Jonsered 2147/ 2150/ 2152/ 2153	544 18 01 03 (Reemplaza a 537 10 55 03)
3	12 47003	34/41/136/137/141/142. Jonsered 2036/ 2040	545 03 68 01 (Reemplaza a 530 01 44 10)
4	12 47004	50/51/55. Ver también ejes de bombas de engrase	503 66 01 02+501 77 76 01
5	12 47005	235/236/240. Jonsered 2234/ 2238	581 06 39 01
6	12 47006	61/162/266/272/268. Jonsered 625/630/670	501 51 25 01
7	12 47007	340/ 345/ 350/ 435/ 440/ 445/ 450. Jonsered 2141/ 2240/ 2245/ 2250 Ver también ejes de bombas de engrase	537 15 48 01+540 05 79 01 503 93 18 01
8	12 47008	40/45. Jonsered 2041/ 2045/ 2050	506 02 77 01
9	12 47009	281/288	503 69 81 01

Línea
AZUL

BOMBAS DE ENGRASE (EJES) (compatible con Husqvarna/Jonsered)



10



11

Nº Referencia	Compatible con modelos	Ref. original
10 12 47010	50/51/55	503 66 01 02
11 12 47011	340/345/350/435/440/445/450. Jonsered 2141/2240/2245	540 05 79 01 (Reemplaza a 503 93 21 01)



BOMBAS DE ENGRASE (compatible con Stihl)



12



13



14



15



16



17



18



19



Nº Referencia	Compatible con modelos	Ref. original
12 12 47014	017/018/021/023/025/MS170/MS171/MS180/MS181/MS210/MS211/MS230/MS250	1123 640 3200
13 12 47015	024/026/MS260/MS240	1121 007 1043
14 12 47016	021/023/025/MS210/MS230/MS250	1123 640 3201
15 12 47017	036/MS360	1125 640 3201
16 12 47018	046/MS460	1128 640 3206
17 12 47019	066/MS660	1122 640 3205
18 12 47020	044/MS440	1128 640 3205
19 12 47021	038	1108 640 3200

BOMBAS DE ENGRASE (compatible con Oleo-Mac)



20

Nº Referencia	Compatible con modelos	Ref. original
20 12 47012	940C/ 941CX/ 947/ 952/ GS410CX/ GS44/ 936/ 942	50170051AR



BRIDAS / CODOS DE ADMISIÓN (compatible con Husqvarna/Jonsered)



1



2



3



4



5

NEW!



6

NEW!



7

NEW!



8

NEW!



9

Nº Referencia	Compatible con modelos	Ref. original
1 12 52002	36/41/51/55/136/137/141/142	503 16 16 02
2 12 52003	365/371/372. Jonsered 2165/2071	503 96 45 01
3 12 52012	340/345/346XP/351/353. (Protección brida de admisión) Jonsered 2141/ 2147/ 2149/ 2150/ 2152/ 2153	503 86 63 02 Ref. Antigua: 503 86 63 01
4 12 52005	40/45. Jonsered 2041/ 2045/ 2050/ GR50/ RS44/ GR41/ GR44	506 01 32 02
5 12 52006	355/357/359. Jonsered 2156/ 2159. Ref. Antigua: 503 92 87 01	503 92 87 02.
6 12 52007	61/266/268/272/281/288	503 49 24 01/501 53 38 03/ 501 80 66 02
7 12 52008	50/51/55 (Soporte)	503 76 48 01
8 12 52010	281/288 (Protección brida de admisión)	501 81 18 01
9 12 52011	268/272 (Goma brida de admisión)	501 65 90 01

BRIDAS / CODOS DE ADMISIÓN (compatible con Oleo-Mac)



11



12



13

Nº Referencia	Compatible con modelos	Ref. original
11 12 52013	936/940C/Efco 136/140S	50050010
12 12 52014	938/941/942/946/951/Efco 138/141/142/146/151	094600018
13 12 52015	947/952	50070010

Línea AZUL

BRIDAS / CODOS DE ADMISIÓN (compatible con Stihl)



14



15



16



17



18



19

Nº Referencia	Compatible con modelos	Ref. original
14 12 52016	038/MS380/MS381	1119 141 2200
15 12 52017	021/023/025/MS210/MS230/MS250	1123 141 2200
16 12 52018	044/046/MS440/MS460	1128 141 2203
17 12 52019	064/066/MS640/MS650/MS660	1122 141 2201
18 12 52020	017/018/MS170/MS180	1130 141 2200
19 12 52021	024/026/MS240/MS260	1121 141 2200

Línea AZUL

BRIDAS / CODOS DE ADMISIÓN (compatible con Stihl)



20



21



22

NEW!



23

Nº Referencia	Compatible con modelos	Ref. original
20 12 52022	034/036/MS340/MS360	1125 141 2200
21 12 52023	MS270/MS280	1133 141 2202
22 12 52024	MS341/361	1135 141 2200
23 12 52026	029/039	1127 141 2200

Línea AZUL

CABLES ACELERADOR (compatible con Husqvarna)



1



2



3

Nº Referencia	Compatible con modelos	Ref. original
1 12 35001	40/45. Jonsered 2041/ 2045/ 2050	506 01 40 04
2 12 35002	51/55	501 77 80 02
3 12 35003	365/371/372. Jonsered 2063/ 2065/ 2163/ 2165/ 2171/ 2172/ 2186/ 2188	503 71 76 01

Línea AZUL

CABLES ACELERADOR (compatible con Oleo-Mac)



4

Nº Referencia	Compatible con modelos	Ref. original
4 12 35004	938/941/942/946/951	94600059

CABLES ACELERADOR (compatible con Partner)



Nº Referencia	Compatible con modelos	Ref. original
5 12 35005	351/370.McCulloch Mac 438/442	530 04 76 02

Línea AZUL

CAMPANAS DE EMBRAGUE (compatible con Husqvarna/Jonsered)



Nº Referencia	Compatible con modelos	Ref. original
1 12 18001	365/372/570/575/576. Jonsered 2065/2165 (Piñón fijo). Para 3/8	503 86 17 03
2 12 18002	365/372/570/575/576 (Piñón recambiable). Jonsered 2065/2071/2165/2171. Kit campana+corona. Para 3/8	586 98 06 01 (Ref. Antigua 503932471 / 537036205)
3 12 18003	340/345/350/445/450. Jonsered CS2245/CS2147/CS2152 /CS2150/CS2245/CS2250. Para 325	578 09 79 01 (Ref. Antigua: 503 87 30 73)
4 12 18004	36/41/136/137/141/142 (Piñón Fijo). 325x7	530 06 93 42
5 12 18005	36/41/136/137/141/142 (Piñón Recambiable). 325x7	530 06 93 16
6 12 18006	61/266/268/272 (Piñón Fijo). 3/8x7	503 65 09 01
7 12 18007	61/266/268/272 (Piñón Recambiable). 3/8x7	501 83 15 04
8 12 18008	281/285/288 (Piñón Fijo). 3/8x7	501 54 02 01
9 12 18009	281/285/288 (Piñón Recambiable). 3/8x7	503 62 59 03

Línea AZUL

Las referencias o alusiones a otras marcas hechas en el catálogo sólo son indicativas y sirven para la comprobación de nuestros productos. Suministramos SÓLO PIEZAS NO ORIGINALES.

CAMPANAS DE EMBRAGUE (compatible con Husqvarna/Jonsered)

NEW!



10

NEW!



11

NEW!



12

NEW!



13

Nº Referencia	Compatible con modelos	Ref. original
10 12 18010	50/51/55 (Piñón Fijo). 325x7	503 088 702
11 12 18011	50/51/55 (Piñón Recambiable). 325x7	503 745 401
12 12 18012	40/45 (Piñón Fijo). 325x7	503 159 802
13 12 18013	65/263 (Piñón Fijo). 3/8x7	501 255 901



CAMPANAS DE EMBRAGUE (compatible con Solo)

NEW!



23

NEW!



24

NEW!



25

NEW!



26

NEW!



27

NEW!



28

Nº Referencia	Compatible con modelos	Ref. original
23 12 18023	635/636 (Piñón Fijo). 3/8x6	350 04 33 25
24 12 18024	643IP (Piñón Fijo). 325x7	350 04 14
25 12 18025	639/645/646/650/651SP/652 (Piñón Fijo). 325x7	350 03 62 25
26 12 18026	651/656 (Piñón Recambiable). 325x7	350 03 72 25
27 12 18027	662/667 (Piñón Recambiable). 3/8x7	350 03 59
28 12 18028	665/675/681 (Piñón Recambiable). 3/8x7	350 02 61

CAMPANAS DE EMBRAGUE (compatible con Stihl)

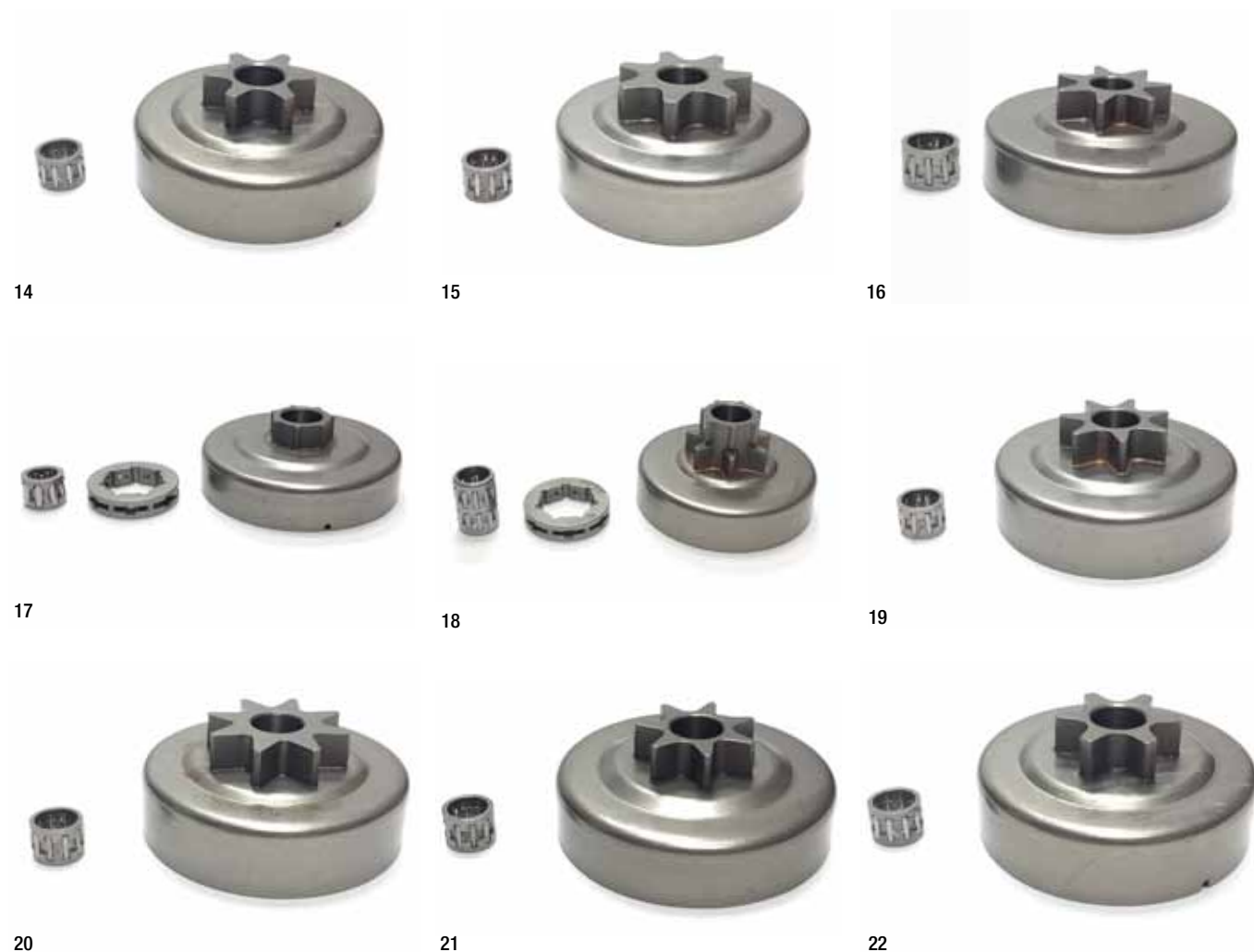

Nº	Referencia	Compatible con modelos	Ref. original
14	12 18014	017/018/019/021/023/025/180/190/250. 3/8x6	1123 640 2073
15	12 18015	023/025/230/250. 3/8x7	1123 640 2072
16	12 18016	029/034/036/039/290/310/360/390. 3/8x7	1125 640 2004
17	12 18017	044/036/440/361. 3/8x7	
18	12 18018	038/ MS380/381. 3/8x7	1119 640 2000
19	12 18019	021/023/025/210/230/250. 325 x 7	1123 640 2074
20	12 18020	021/023/025/210/230/250. 325 x 8	1123 640 2076
21	12 18021	024/026/240/260/270. 325x7	1121 640 2001
22	12 18022	029/034/036/039/310/360/390. 3/8x7	

Linea AZUL

Las referencias o alusiones a otras marcas hechas en el catálogo sólo son indicativas y sirven para la comprobación de nuestros productos. Suministramos SÓLO PIEZAS NO ORIGINALES.

CAPOT (compatible con Husqvarna/Jonsered)



Nº	Referencia	Compatible con modelos	Ref. original
1	12 72004	365/371/372 (capot tapa filtro)	503 62 80 01
2	12 72005	365/372/385/390/345/355/535/543/545/553/555 (grapa capot)	503 74 01 02

Línea AZUL

CAPUCHONES DE BUJÍA (compatible con Husqvarna/Jonsered)



Nº	Referencia	Compatible con modelos	Ref. original
1	12 14001	5/7 mm	501 48 54 02

Línea AZUL

CAPUCHONES DE BUJÍA (compatible con Stihl)



Nº	Referencia	Compatible con modelos	Ref. original
2	12 14002	026/036/038/044/046/066	1128 405 1000

Línea AZUL

CARBURADORES (compatible con Husqvarna/Jonsered)

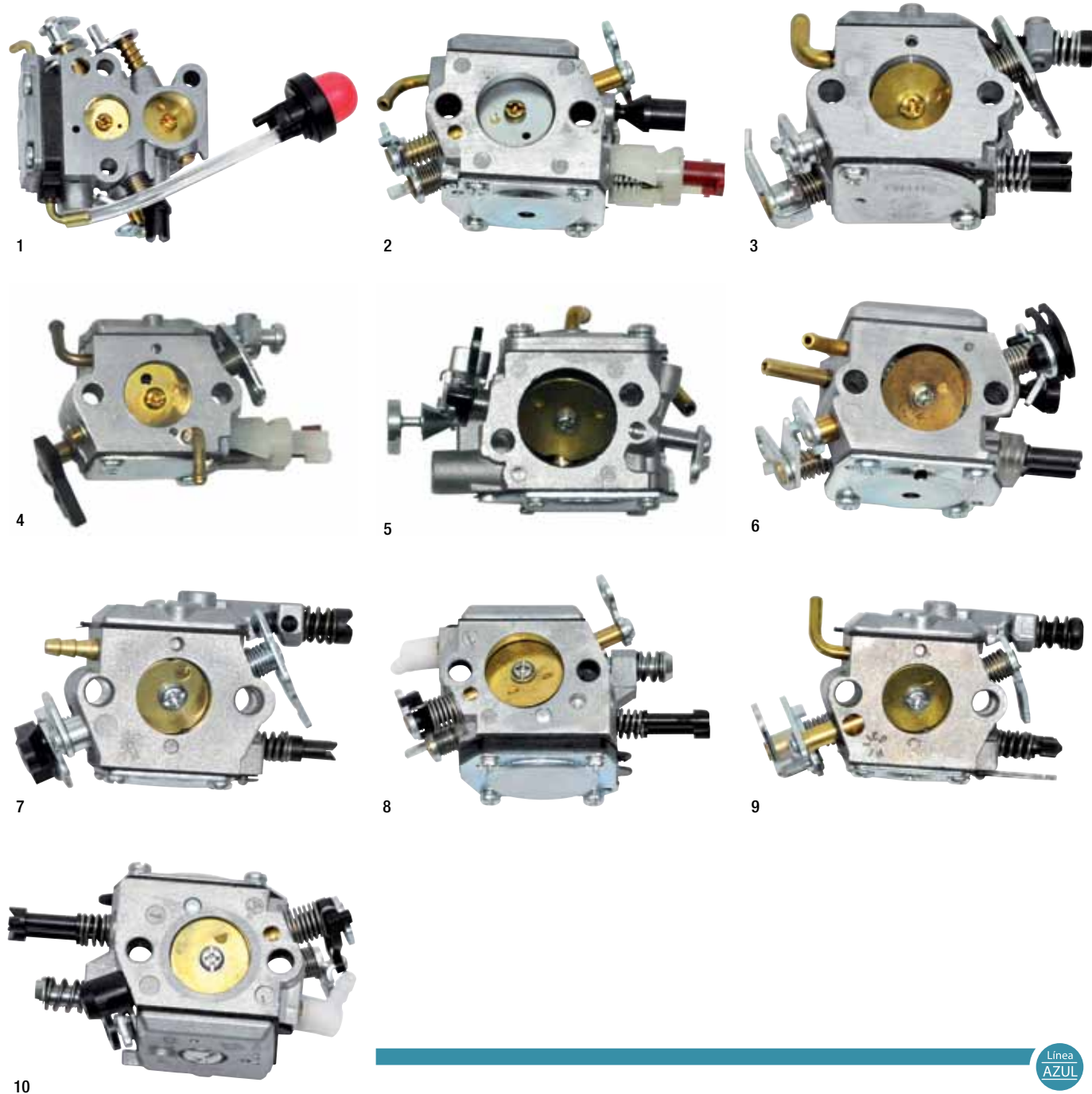

Nº	Referencia	Compatible con modelos	Ref. original
1	12 30042	Zama compatible con 235/235E/236/240/240E/McCulloch CS 340/380 (Desbrozadora). Jonsered 2234/2238	C1T-W33B
2	12 30002	Zama compatible con 340/345/346XP/350/351/353	C3-EL18B
3	12 30003	Zama compatible con 40/45	C1Q-EL1
4	12 30004	Zama compatible con 356	C1Q-EL27
5	12 30005	Walbro compatible con 365 X-Torq/372 X-Torq/B156	RWJ-4B
6	12 30006	Tillotson compatible con 365	HE-18A
7	12 30007	Walbro compatible con 51/55	WT-170
8	12 30008	Walbro compatible con 357XP/359XP	HDA-198
9	12 30009	Walbro compatible con 36/41/136/137/141/142	WT-834-1
10	12 30010	Walbro compatible con 340/345/346XP/351/353	HDA-195 (Reemplaza HDA-154C)

Línea AZUL

Las referencias o alusiones a otras marcas hechas en el catálogo sólo son indicativas y sirven para la comprobación de nuestros productos. Suministramos SÓLO PIEZAS NO ORIGINALES.

CARBURADORES (compatible con Husqvarna/Jonsered)



11



12



13



14



15



16



17

Línea AZUL

Nº	Referencia	Compatible con modelos	Ref. original
11	12 30011	Tillotson compatible con 61/268/272	HS-254B
12	12 30012	Walbro WT-99. Husqvarna 40/45/240R/245R/245RX	WT-99
13	12 30013	Walbro HDA-35B. Husqvarna 254 (Nuevo modelo) Reemplaza a HDA-18	HDA-35B
14	12 30014	Walbro HDA-120. Husqvarna 254/257/262XP	HDA-120
15	12 30015	Walbro HDA-98. Husqvarna 42/242/246XP	HDA-98
16	12 30016	Zama C3-EL17-B. Husqvarna 340/345/346XP/350/351/353	C3-EL17B
17	12 30017	Zama C1Q-EL6. Husqvarna 51/55	C1Q-EL6

CARBURADORES (compatible con Oleo-Mac)



18

Nº	Referencia	Compatible con modelos	Ref. original
18	12 30023	Walbro HDA-160. Oleo-Mac 956/962/965. Efco 156/162	HDA-160

Línea AZUL

CARBURADORES (compatible con Stihl)



19



20



21

Nº Referencia	Compatible con modelos	Ref. original
19 12 30018	Tillotson compatible con 021/023/025/MS210/MS230/MS250	HU-132
20 12 30019	Tillotson compatible con 038/MS380/381	HE-19A
21 12 30020	Walbro WT-215. Stihl 023/025/MS230/MS250	WT-215

Línea AZUL

CARBURADORES (compatible con Dolmar/Makita)



22



23

Nº Referencia	Compatible con modelos	Ref. original
22 12 30021	Walbro WT-506. Dolmar 100/102/PS340/PS400/PS401/ Makita DCS 340/ DCS 341/ DCS 410	WT-506
23 12 30022	Zama C1Q-DM9B. Dolmar P34/Makita DCS34	C1Q-DM9B

Línea AZUL

CARBURADORES (compatible con Partner)



24

Nº Referencia	Compatible con modelos	Ref. original
24 12 30024	Walbro WT-625. Partner 351/370/390/391/420	WT-625

Línea AZUL

CASQUILLO PALANCA DE FRENO

(compatible con Husqvarna/Jonsered)

NEW!



1

Nº Referencia	Compatible con modelos	Ref. original
1 12 73001	365/371/372/385/390 (Ø=10,16; D=18,53; H=7,55)	503 77 52 01

Línea AZUL

CEBADORES / BOMBINES DE CARBURADOR



1



2



3

Nº Referencia	Compatible con modelos	Ref. original
1 12 29001	Universal	
2 12 29002	Walbro WT / WY / WYJ / WYK / WYP / WZ. Kawasaki TJ	W 188-12
3 12 29003	Walbro HDA / WYK. Kawasaki TH	W 188-13

Línea AZUL

CHAPA DE CADENA / CHAPA DE ENGRASE

(compatible con Husqvarna)

NEW!



1

NEW!



2

NEW!



3

NEW!



4

Nº Referencia	Compatible con modelos	Ref. original
1 12 36001	340/345/350 (Interior)	503 87 57 01
2 12 36002	340/345/346/350/351/ 353/357/359 (Exterior)	503 85 66 01
3 12 36003	61/66/266/268/272/281/ 288 (Interior)	501 81 48 01
4 12 36004	365/372/385/390	537 04 66 01

Línea AZUL

CHAPA DE CADENA / CHAPA DE ENGRASE

(compatible con Stihl)

NEW!



5

Nº Referencia	Compatible con modelos	Ref. original
5 12 36007	044/046/064/066/MS440/ 441/460/640/650/660	1128 664 1001

Línea AZUL

CIGÜEÑALES (compatible con Husqvarna/Jonsered)

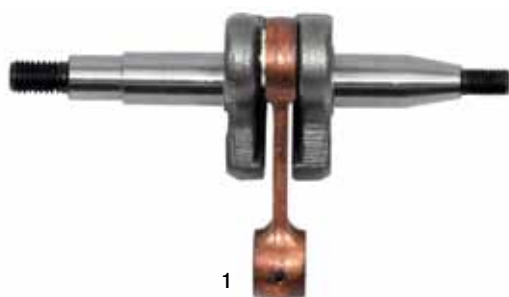

1

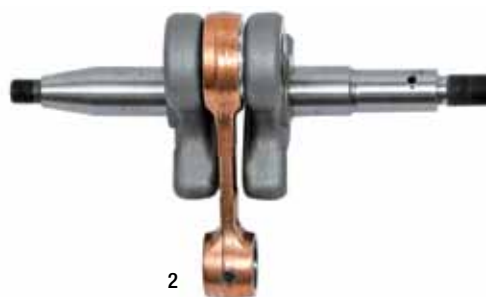

2

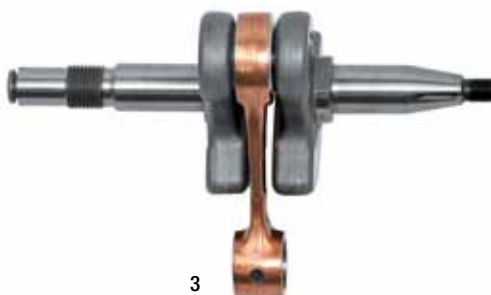

3

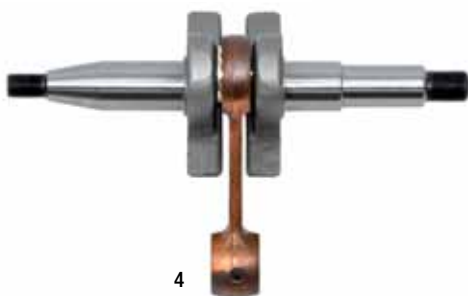

4

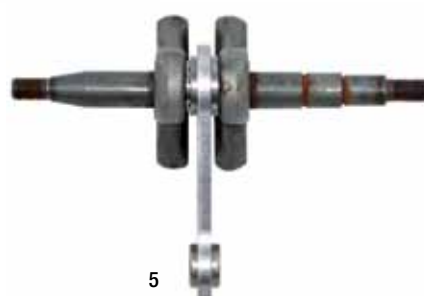

5

Nº Referencia	Compatible con modelos	Ref. original
1 12 37001	40/45/51/55/240R/245R. Jonsered 2041/2045/2050/GR41/GR50/RS44	503 57 38 06
2 12 37003	61/66/266/268/272. Jonsered 630/670	503 61 33 71
3 12 37004	365/372. Jonsered 2065/2071 /2165/2172/	503 74 87 03 Ref. Antigua: 503 72 91 76
4 12 37005	340/345/350. Jonsered 2145/2150	503 85 80 71
5 12 37006	36/41/136/137/141/142. Jonsered 2036/2040	503 92 08 01 Ref. Antigua: 530 02 97 94

Línea AZUL

CIGÜEÑALES (compatible con Stihl)



6



7



8



9

Nº	Referencia	Compatible con modelos	Ref. original
6	12 37007	025/MS250	1123 030 0410
7	12 37008	044/MS440	1128 030 0406
8	12 37009	029/039/MS290/MS390	1127 030 0402
9	12 37010	038/038S/038 Magnum	1119 030 0400

Línea AZUL

CONJUNTOS DE ARRANQUE (compatible con Husqvarna/Jonsered)



1



2



3



4



5



6

Nº	Referencia	Compatible con modelos	Ref. original
1	12 41001	61/266/268/272	503 61 55 71
2	12 41002	50/51/55	503 60 88 03
3	12 41003	365/371/372	503 62 81 71
4	12 41004	281/288	501 81 00 06
5	12 41005	340/345/346/350/351/353	537 10 47 02
6	12 41006	136/137/141/142. Arranque fácil	530 07 19 68

CONJUNTOS DE ARRANQUE (compatible con Stihl)



7



8



9



10



11



12



13



14

Nº	Referencia	Compatible con modelos	Ref. original
7	12 41007	021/023/025	1123 080 2104
8	12 41008	064/066/MS640/MS660	1122 080 2110
9	12 41009	044/046/MS440/MS460	1128 080 2104
10	12 41010	MS340/360	1125 080 2105
11	12 41011	MS240/MS260	1121 080 2101
12	12 41012	017/018/025/MS170/MS180	1130 080 2100
13	12 41013	029/039/MS290/MS310/MS390	1127 080 2103
14	12 41014	038	1119 080 1800

Línea AZUL

Las referencias o alusiones a otras marcas hechas en el catálogo sólo son indicativas y sirven para la comprobación de nuestros productos. Suministramos SÓLO PIEZAS NO ORIGINALES.

CORONAS PIÑONES

Línea AZUL



Nº	Referencia	Compatible con modelos	Ref. original
1	12 19001	Corona 325x7	501 45 74 02
2	12 19002	Corona 3/8 x 7 (grande)	501 59 80 02
3	12 19003	Corona 3/8 x 7 (pequeña)	504 52 30 02
4	12 19004	Corona 3/8 x 8	505 30 36 61

DEFLECTOR DE AIRE (compatible con Husqvarna/Jonsered)



Nº	Referencia	Compatible con modelos	Ref. original
1	12 41015	61/268/272	501 65 92 01
2	12 41017	365/371/372	503 62 83 01

DEPÓSITO DE GASOLINA (compatible con Husqvarna/Jonsered)



Nº	Referencia	Compatible con modelos	Ref. original
1	12 62001	362/365/371/372	544 11 40 07
2	12 62002	61/266/268/272	501 69 90 10
3	12 62003	340/345/346/350/351/353	503 86 37 03

EMBRAGUES (compatible con Husqvarna/Jonsered)



Nº	Referencia	Compatible con modelos	Ref. original
1	12 17026	281/288/385/390/395. Jonsered 2095	503 70 15 02
2	12 17002	365/371/372. Jonsered 2065/2071/2165/2171	503 74 44 01
3	12 17003	61/268/272. Jonsered 625/630/670	503 74 44 02
4	12 17004	51/55/154/254/257	537 11 05 02 Ref.Antigua 501 45 54 03
5	12 17005	340/345/346/350/353/445/445E/450/455/460. Jonsered 2147/2152/2153/2245/2250/2255	537 11 05 03
6	12 17006	357/359. Jonsered 2156/2159	537 10 34 03
7	12 17007	36/41/135/136/137/141/142/230/235/236/240. Partner 351	530 01 49 49

Linea AZUL

EMBRAGUES (compatible con Stihl)



Nº	Referencia	Compatible con modelos	Ref. original
8	12 17008	029/034/039/MS290/MS310/MS340/MS390	1127 160 2051
9	12 17028	MS360/MS440/MS460	1125 165 2052/ 2006
10	12 17010	017/018/021/023/025/MS170/MS180/MS210/MS230/MS250	1123 160 2050
11	12 17014	068/MS380/MS381	1119 160 2000

EMBRAGUES (compatible con Stihl)



12



13

Nº Referencia	Compatible con modelos	Ref. original
12 12 17012	064/066/MS640/MS660	1122 160 2005
13 12 17013	024/026/MS240/MS260/MS270/MS280	1121 160 2051

Linea AZUL

ESCAPES (compatible con Husqvarna/Jonsered)



1



2



3



4



5

NEW!



6

Nº Referencia	Compatible con modelos	Ref. original
1 12 49001	36/41/136/137/141/142	530 06 94 15
2 12 49002	50/51/55	501 76 66 05 (Reemplaza a 501 76 66 02)
3 12 49003	355/357/359. Jonsered 2156/2159	504 70 69 01 (Reemplaza a 503 91 76 01)
4 12 49004	362/365/371/372. Jonsered 2065/2071/2165/2171	544 02 95 01 (Reemplaza a 503 76 53 01)
5 12 49005	340/345/350. Jonsered 2141/2145/2150	544 02 84 01 (Reemplaza a 503 87 96 02)
6 12 49006	61/268/272. Jonsered 630-670	503 47 69 01

Linea AZUL

ESCAPES (compatible con Stihl)



Nº	Referencia	Compatible con modelos	Ref. original
7	12 49007	017/018/MS170/MS180	1130 140 0600
8	12 49008	029/039/MS290/MS390	1127 140 0601
9	12 49009	021/023/025/MS210/MS230/MS250	1123 140 0601
10	12 49010	026/MS260	1121 140 0604
11	12 49011	381	1119 140 0604
12	12 49012	038/038S	1119 007 1005
13	12 49013	034/036/MS340/MS360	1125 140 0607

Línea AZUL

FILTRO DE ACEITE (Universal)



Nº	Referencia	Compatible con modelos	Ref. original
1	12 11001		501 54 41 02

Línea AZUL

FILTRO DE ACEITE (compatible con Stihl)



Nº	Referencia	Compatible con modelos	Ref. original
2	12 11002	MS060	
3	12 11003	MS210/MS230/MS250	1123 640 3800

Linea AZUL

FILTRO DE AIRE (compatible con Alpina)



Nº	Referencia	Compatible con modelos	Ref. original
1	12 10001	P370/P410	8781610

Linea AZUL

FILTRO DE AIRE (compatible con Husqvarna/Jonsered)



Nº	Referencia	Compatible con modelos	Ref. original
2	12 10002	61/66/266/281/288. Filtro grueso	501 80 71 05 Jonsered 503 77 39 03
3	12 10003	340/345/346/350/351/353 Jonsered 2141/ 2145/ 2147/ 2149/ 2150/ 2152	537 02 40 01/02
4	12 10004	362/365/371/372 Jonsered 2065/ 2071/ 2165/ 2171	575 26 91 03 (Ref. Antigua 503 81 45 03)

Linea AZUL

FILTRO DE AIRE (compatible con Husqvarna/Jonsered)



5



6



7



8



9

Nº	Referencia	Compatible con modelos	Ref. original
5	12 10005	51/55 Rancher	503 89 81-01
6	12 10006	40/45. Jonsered 2041/ 2045/ 2050	503 41 32 01
7	12 10007	36/41/136/137/141/142	530 02 99 08
8	12 10008	235/236/240. Jonsered 2234/ 2238	545 06 18 01
9	12 10009	357/359. Jonsered 2156/2159	537 01 09 02

Línea AZUL

FILTRO DE AIRE (compatible con Oleo-Mac)



10

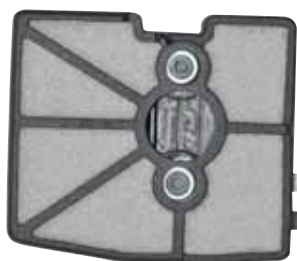

11



12



13

Nº	Referencia	Compatible con modelos	Ref. original
10	12 10010	936-940C/Efco 136-140C	500 50036A
11	12 10011	942-946/Efco 142-146-151	946 00036B
12	12 10012	947-952/Efco 147-152	500 70036
13	12 10013	937/941C/GS370/GS410C/GS410CX-Efco 137-141C	501 70036

Línea AZUL

FILTRO DE AIRE (compatible con Partner)



14

Nº Referencia	Compatible con modelos	Ref. original
14 12 10014	350/351	530 03 77 93

Linea AZUL

FILTRO DE AIRE (compatible con Stihl)



15



16



17



18



19



20



21

Nº Referencia	Compatible con modelos	Ref. original
15 12 10015	017/018/MS170/MS180	1130 124 0800
16 12 10016	021/023/025/MS210/MS230/MS250	1123 120 1612
17 12 10017	044/046/064/066/MS440/MS441/MS441C/MS460/MS650	1120 120 1610
18 12 10018	029/039/MS290/MS310/MS390	1127 120 1621
19 12 10019	024/026/MS240/MS260	1121 120 1617
20 12 10020	MS070	1106 120 1602
21 12 10003	MS380 (igual Husqvarna 340; Ref: 537 02 40-02)	1123 120 1613

FILTROS DE GASOLINA (compatible con Stihl)



1

Nº Referencia	Compatible con modelos	Ref. original
1 12 11004	Filtro de gasolina D: 15 mm; Tubo: 5,7 mm	0000 350 3506

Línea AZUL

FILTROS DE GASOLINA (Universal)



2



3



4



5

Nº Referencia	Compatible con modelos	Ref. original
2 12 11005	Filtro de gasolina-D: 19 mm Tubo-D: 5mm	
3 12 11011	Filtro de gasolina-D: 20 mm; Largo filtro: 31 mm; Tubo-D: 6 mm; Largo tubo: 11 mm	
4 12 11013	Filtro de gasolina	
5 12 11014	Bolsa filtros de gasolina- 10 unidades	

Línea AZUL

FLEJES DE FRENO (compatible con Husqvarna/Jonsered)



1



2

Nº Referencia	Compatible con modelos	Ref. original
1 12 73002	266/268/272/281/288	503 70 40 02
2 12 73008	340/345/350/351/357/359/445/450/455/460	537 04 30 01

Línea AZUL

GATILLOS Y SEGUROS (compatible con Husqvarna/Jonsered)



Nº	Referencia	Compatible con modelos	Ref. original
1	12 35006	Gatillo gas 61/162/266/268/272. Jonsered 625, 630,670	501 51 80 02
2	12 35007	Seguro gas 340/345/346/350/351/353/357/359. Jonsered CS2150, CS2145, CS2156, CS2147, CS2159, CS 2141, CS 2152, CS 2149	503 85 44 01
3	12 35008	Seguro gas 365/371/372. Jonsered CS2150, CS2145, CS2156, CS2147, CS2159, CS 2141, CS 2152, CS 2149	503 55 66 01
4	12 35009	Gatillo acelerador 365/372	503 82 98 01
5	12 35011	Kit Gatillo acelerador 36/41/136/137/141/142	530 06 95 87
6	12 35010	Seguro gas 61/261/266/268	501 51 81 02

Linea AZUL

GATILLOS Y SEGUROS (compatible con Stihl)



Nº	Referencia	Compatible con modelos	Ref. original
8	12 35016	017/018/MS170/MS180	1130 182 1000
9	12 35035	Gatillo gas Stihl 021/023/025/029/039/044/046/MS440/460	1128 182 1005
10	12 35036	Seguro gas Stihl MS440/460	1117 182 0805

GUÍAS DE CADENA (compatible con Husqvarna/Jonsered)



1

Nº Referencia	Compatible con modelos	Ref. original
1 12 57001	Compatible con todos los Husqvarna. Jonsered 2065/ 2071/ 2165/ 2171/ 2077/ 625/ 630/ 670	501 51 72 01

Línea
AZUL

GUÍAS DE CADENA (compatible con Stihl)



2

Nº Referencia	Compatible con modelos	Ref. original
2 12 57002	Compatible con Stihl 026/038/044/046/066	1121 648 6610

Línea
AZUL

INTERRUPTORES DE PARE (compatible con Husqvarna/Jonsered)

1



2



3



Nº Referencia	Compatible con modelos	Ref. original
1 12 22015	40/45. Jonsered 2041/ 2045/ 2050	538 24 34 40 Ref. Antigua: 503 71 80 01
2 12 22016	55/61/266/272/281/312/395	503 71 79 01
3 12 22017	365/372/240R/325R/232R/235R/240R/245R/343R/345R. Jonsered BC2145/2186	503 71 82 01

Línea
AZUL

INTERRUPTORES DE PARE (compatible con Oleo-Mac)



4

Nº Referencia	Compatible con modelos	Ref. original
4 12 22018	936/938/940/941/942/946/947/952/953/962-Efco-Alpina-Stiga-Partner 351/370	2317011

Línea AZUL

INTERRUPTORES DE PARE (compatible con Stihl)



5

Nº Referencia	Compatible con modelos	Ref. original
5 12 22019	026/034/036/038/MS260/MS360	1110 430 0202

Línea AZUL

INTERRUPTORES DE PARE (Universal para motosierras)

NEW!



6

Nº Referencia	Compatible con modelos	Ref. original
6 12 22020		

Línea AZUL

JUEGOS DE JUNTAS MOTOR (compatible con Husqvarna/Jonsered)

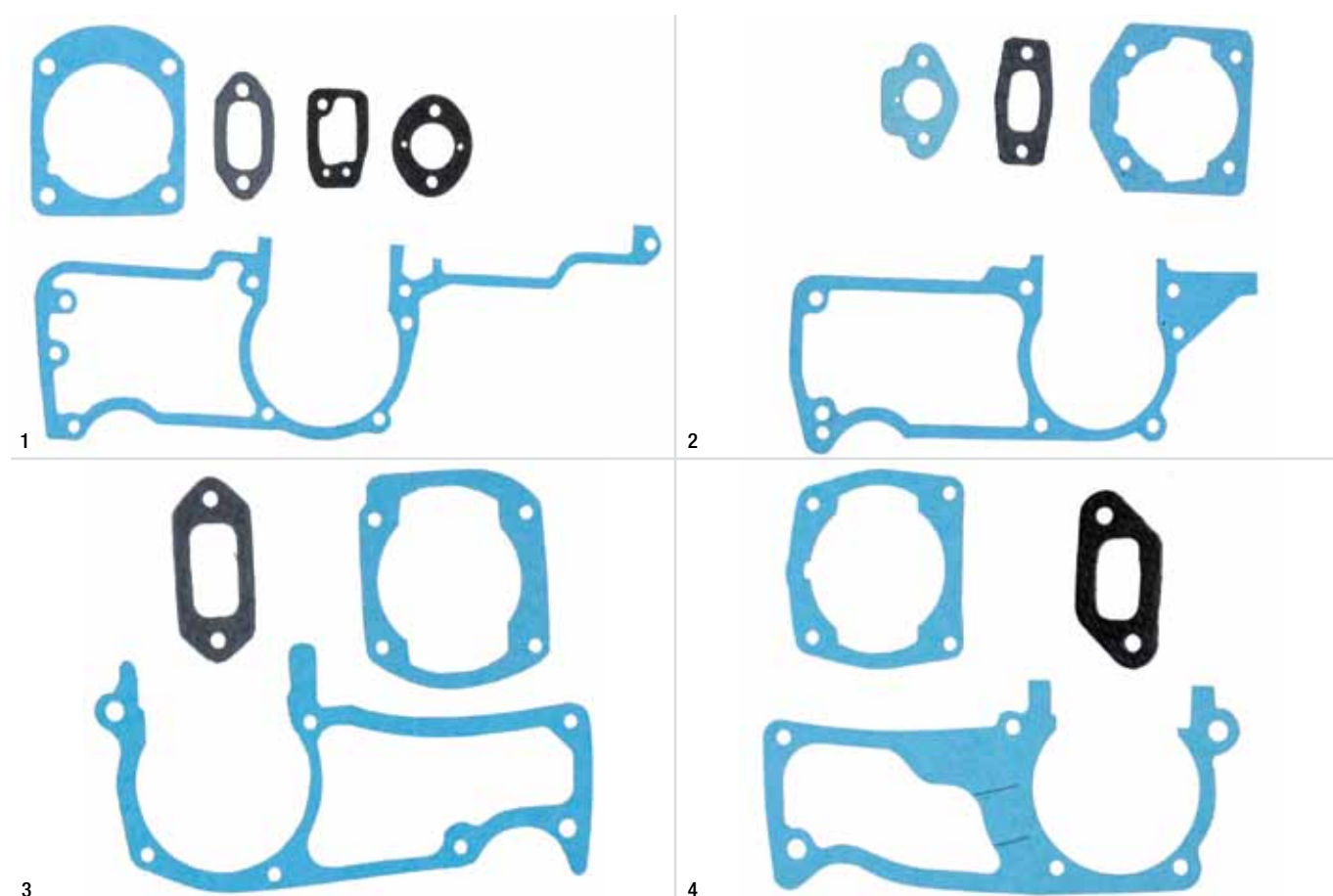

Nº	Referencia	Compatible con modelos	Ref. original
1	12 33024	268/272	501 52 26 04
2	12 33002	50/51/55	501 76 18 02
3	12 33003	365/371/372. Jonsered 2065/ 2071/ 2165/ 2171	503 64 72 01
4	12 33004	357/359. Jonsered 2156/2159	503 97 85 01

Línea AZUL

JUEGOS DE JUNTAS MOTOR (compatible con Oleo-Mac)

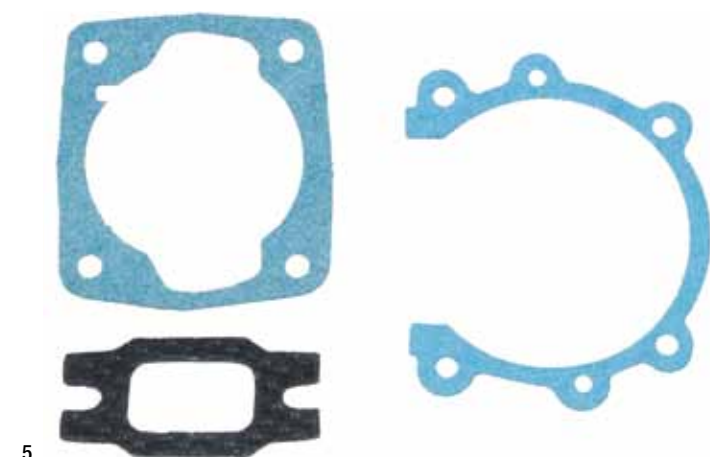

Nº	Referencia	Compatible con modelos	Ref. original
5	12 33005	938/941/942/946/951/Efco 138,141,142,146,151	

JUEGOS DE JUNTAS MOTOR (compatible con Stihl)

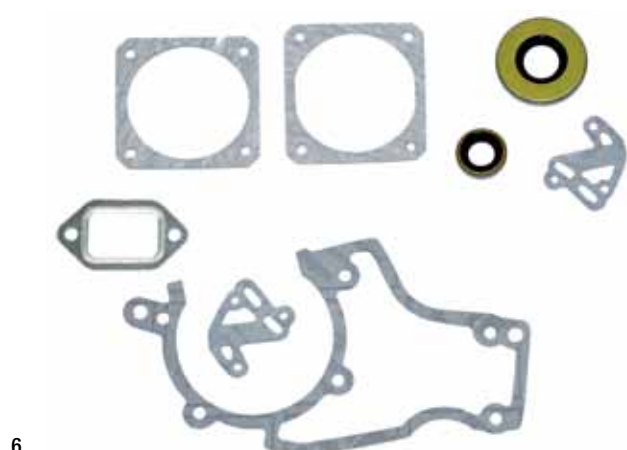

6

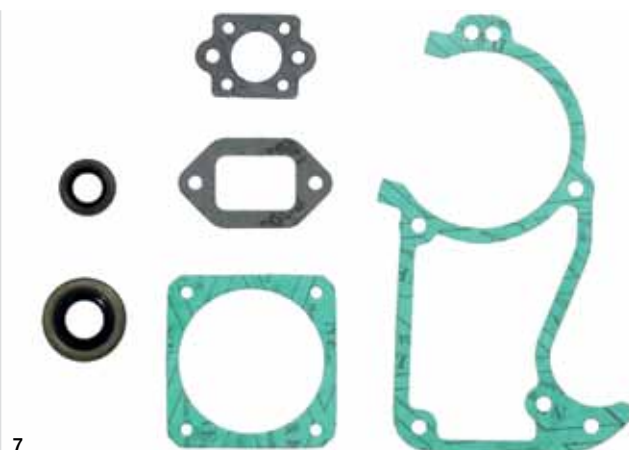

7

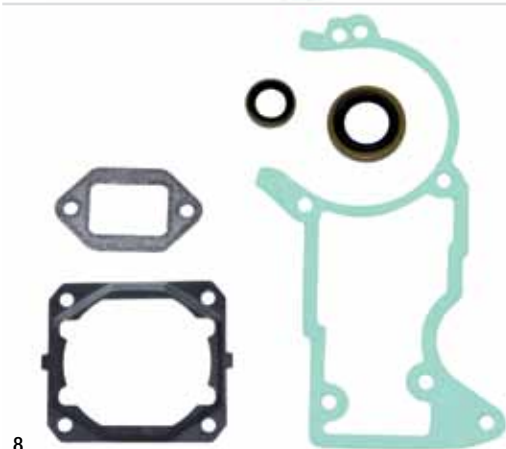

8

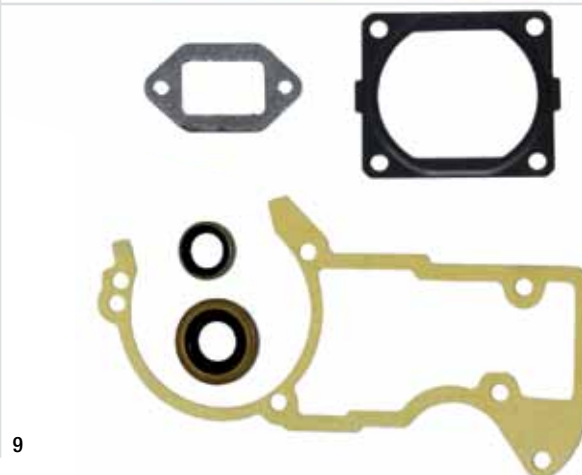

9

Nº	Referencia	Compatible con modelos	Ref. original
6	12 33006	038/038S/MS380 Magnum	1119 007 1050
7	12 33007	036/MS360	1125 007 1050
8	12 33008	044/MS440	1128 007 1050
9	12 33009	046/MS460	1128 007 1052

Línea AZUL

JUEGOS DE JUNTAS MOTOR (compatible con Stihl)

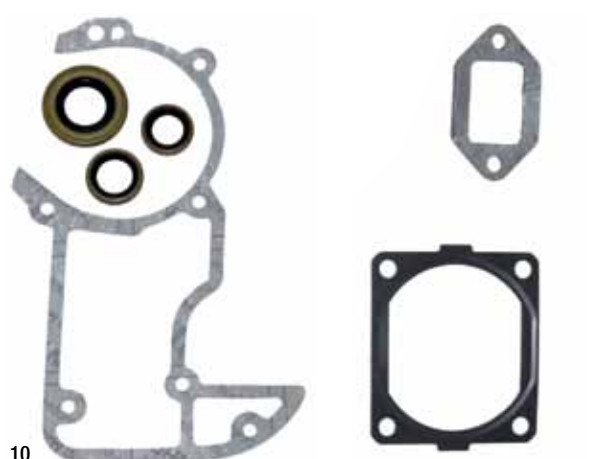

10



11

Nº	Referencia	Compatible con modelos	Ref. original
10	12 33010	066/MS660	1122 007 1053
11	12 33011	021/023/025/MS230/MS250	1123 129 0900/1123 149 0500

JUNTAS DE CILINDRO (compatible con Stihl)

NEW!



1

Nº Referencia	Compatible con modelos	Ref. original
1 12 33022	044/MS440	1128 029 2301

Línea AZUL

KITS CILINDRO+PISTÓN (compatible con Husqvarna/Jonsered)



1



2



3

SI EL CILINDRO ANTIGÜO TIENE ESTE TIPO DE ADMISIÓN, HAY QUE PEDIR A MAYORES LA REF. 12 52003



Nº Referencia	Compatible con modelos	Ref. original
1 12 20001	61 (Diámetro 48 mm)	544 22 28 02 Ref.Antigua 503 53 20 71
2 12 20002	268 (Diámetro 50 mm)	544 22 29 02 Ref. Antigua: 503 61 10 71
3 12 20003	365 / Jonsered 2065/ 2165 (Diámetro 48 mm)	503 93 90 05 Ref.Antigua: 503 93 90 71

Línea AZUL

Las referencias o alusiones a otras marcas hechas en el catálogo sólo son indicativas y sirven para la comprobación de nuestros productos. Suministramos SÓLO PIEZAS NO ORIGINALES.

KITS CILINDRO+PISTÓN (compatible con Husqvarna/Jonsered)

SI EL CILINDRO ANTIGÜO TIENE ESTE TIPO DE ADMISIÓN, HAY QUE PEDIR A MAYORES LA REF. 12 52003



Nº	Referencia	Compatible con modelos	Ref. original
4	12 20004	51 (Diámetro 45 mm)	503 92 41 71/503 16 83 01
5	12 20005	55 (Diámetro 46 mm)	503 60 91 71
6	12 20006	372. Jonsered 2071/ 2171 (Diámetro 50 mm)	503 93 93 72. Ref.Antigua: 503 62 64 73
7	12 20007	340. Jonsered 2141 (Diámetro 40 mm)	503 87 00 05. Ref.Ant: 503 87 00 73/503 87 00 76
8	12 20008	345. Jonsered 2145 (Diámetro 44 mm)	503 87 02 76
9	12 20009	357. Jonsered 2156 (Diámetro 46 mm)	537 24 85 02
10	12 20010	359. Jonsered 2159 (Diámetro 47 mm)	537 15 73 04. Ref.Antigua: 537 15 73 02
11	12 20011	353. Jonsered 2153 (Diámetro 45 mm)	537 25 31 02
12	12 20012	235/236/240E. Jonsered 2234/ 2238	574 29 10 01
13	12 20013	45/245R (Diámetro 42 mm)	503 44 08 02
14	12 20048	455 (Diámetro 47 mm)	537 32 04 02

KITS CILINDRO+PISTÓN (compatible con Husqvarna/Jonsered)



16



17



18

Nº Referencia	Compatible con modelos	Ref. original
16 12 20042	372X-Torq (Diámetro 50 mm)	575 25 57 02
17 12 20046	36/136/137 (Diámetro 38 mm)	530 06 99 40 & 530 06 99 44
18 12 20047	41/141/142 (Diámetro 40 mm)	530 06 99 41 & 530 06 94 54

Línea AZUL

KITS CILINDRO+PISTÓN (compatible con Stihl)



19



20



21



22



23



24

Nº Referencia	Compatible con modelos	Ref. original
19 12 20015	017/MS170 (Diámetro 37 mm)	1130 020 1207
20 12 20043	018/MS180 (Diámetro 38 mm)	1130 020 1208
21 12 20044	MS181 (Diámetro 39 mm)	1139 020 1203
22 12 20045	024/MS240 (Diámetro 42 mm)	1121 020 1200
23 12 20016	034/036/MS360 (Diámetro 48 mm)	1125 020 1213 / 1125 020 1215/1216
24 12 20017	044/MS440/450/455 (Diámetro 50 mm). Bulón 12 mm	1128 020 1227

Línea AZUL

KITS CILINDRO+PISTÓN (compatible con Stihl)

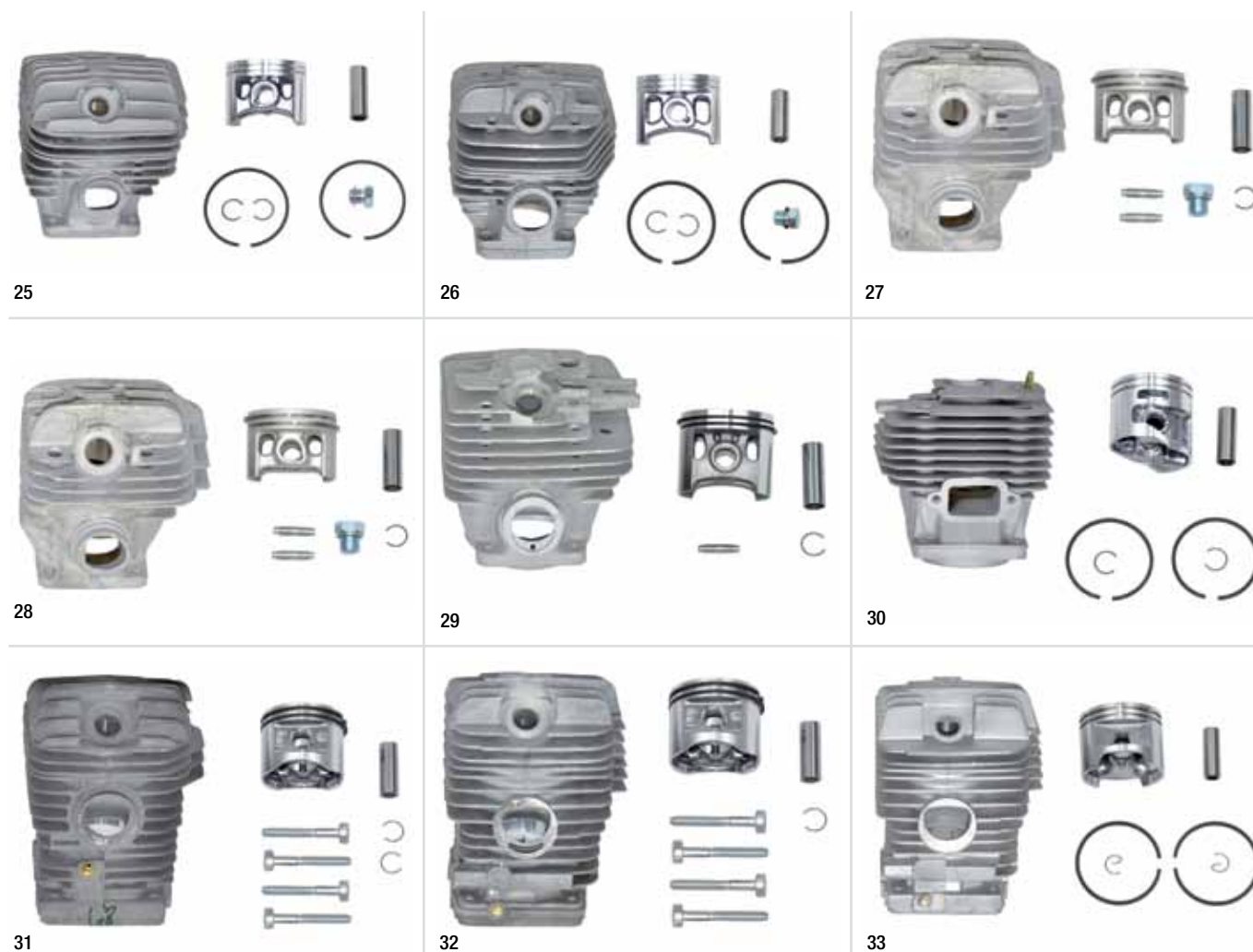

Nº	Referencia	Compatible con modelos	Ref. original
25	12 20018	046/MS460 (Diámetro 52 mm)	1128 020 1221
26	12 20019	066/MS660 (Diámetro 54 mm)	1122 020 1211
27	12 20049	025/MS250 (Diámetro 42,5 mm)	1123 020 1206
28	12 20021	026/MS260 (Diámetro 44 mm)	1121 020 1203
29	12 20022	MS361 (Diámetro 47 mm)	1135 020 1202
30	12 20023	MS441 (Diámetro 50 mm)	1138 020 1201
31	12 20024	023/MS230 (Diámetro 40 mm)	1123 020 1214
32	12 20050	029/MS290 (Diámetro 46 mm)	1127 020 1217
33	12 20026	039/MS390 (Diámetro 49 mm)	1127 020 1216

Línea AZUL

MUELLES DE ARRANQUE (compatible con Alpina/Stiga)



Nº	Referencia	Compatible con modelos	Ref. original
1	12 24001	360/370/380/390/400/410/ 450/460/510/ Stiga P 34/ PR350 P360/370/380/390/410/460/510. ø: 5mm	4611480

MUELLES DE ARRANQUE (compatible con Husqvarna/Jonsered)



2

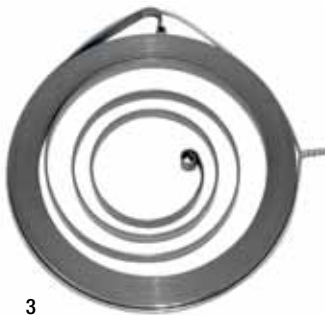

3



4



5



6

NEW!



7

Nº	Referencia	Compatible con modelos	Ref. original
2	12 24002	36/40/41/45/51/55/136/141/240R/245R. ø:7mm	501 76 31 01
3	12 24003	61/162/266/268/272/281/288. ø:5mm	501 52 04 02
4	12 24004	340/340E/345/345E/346/350/351/353/357/359. Arranque fácil	537 42 34 01
5	12 24005	340/340E/345/345E/346/350/351/353/357/359. Hasta 2002. ø:5mm	503 85 99 01
6	12 24006	365/372/385/390. ø:5mm	503 78 72 01
7	12 24014	137E-142E-235E-236E-240E (arranque fácil)	530 02 11 80

Línea AZUL

MUELLES DE ARRANQUE (compatible con Oleo-Mac/Efco)



8

NEW!



9

NEW!



10

Nº	Referencia	Compatible con modelos	Ref. original
8	12 24007	Oleo Mac+ Efco 135/138/140/141/142/145/146/151/935/938/940/941/942/945/946/951 / Universal para trimmers. ø: 5mm	004000132
9	12 24012	260/261/264/271/272/284	60.00.132 / 60.00.963
10	12 24013	936/940/937/947/952	

Línea AZUL

MUELLES DE ARRANQUE (compatible con Partner)



11

Línea AZUL

Nº Referencia	Compatible con modelos	Ref. original
11 12 24008	350/351/370/371/351XT/Ikra KSB 3940/ McCulloch Mac 438,422 ø: 5mm	545 00 80 15 Ref.Antigua: 530 02 75 31

MUELLES DE ARRANQUE (compatible con Stihl)



12



13



14

Nº Referencia	Compatible con modelos	Ref. original
12 12 24009	026/028/034/MS260/MS340. ø:6mm	1118 190 0600
13 12 24010	017/018/021/023/025/029/036/044/046/MS170/MS180/MS210/ MS230/MS250/MS340. ø:5mm	1129 190 0601
14 12 24011	038/070. ø:6mm	1117 190 0601

Línea AZUL

MUELLES DE EMBRAGUE (compatible con Husqvarna/Jonsered)



1



2



3

Nº Referencia	Compatible con modelos	Ref. original
1 12 21001	40/45/51/55/254/257/240R/245R/240RX/245RX. Para embragues de un solo muelle.	501 45 61 01
2 12 21002	61/162/266/268/272. Para embragues de un solo muelle	501 40 34 02
3 12 21003	268/365/372/570/575. Jonsered 2065/2071/2165/2171	537 36 06 01 Ref.Antigua 503 74 43 01

MUELLES DE EMBRAGUE (compatible con Husqvarna/Jonsered)



4



5



6

NEW!



7

Nº	Referencia	Compatible con modelos	Ref. original
4	12 21004	288/395	503 14 51 01
5	12 21005	340/345/350. Jonsered 2141/ 2145/2147/2150/2152 Ref. Antigua: 537 08 00 01/ 503 81 56 01	537 35 91 01
6	12 21006	357/359	537 16 69 01
7	12 21007	36/41/135/136/137/141/ 142/235/236/240-Partner 351/371	530 09 41 88

Línea AZUL

MUELLES DE EMBRAGUE (compatible con Stihl)



8



9



10



11



12

NEW!



13

Nº	Referencia	Compatible con modelos	Ref. original
8	12 21008	026	0000 997 5600
9	12 21009	066	0000 997 0911
10	12 21010	018/023/025	0000 997 5515
11	12 21011	029/039	0000 997 0909
12	12 21012	036/044/046	0000 997 5815
13	12 21013	038	0000 997 0907

Las referencias o alusiones a otras marcas hechas en el catálogo sólo son indicativas y sirven para la comprobación de nuestros productos. Suministramos SÓLO PIEZAS NO ORIGINALES.

MUELLES GATILLO (compatible con Husqvarna/Jonsered)

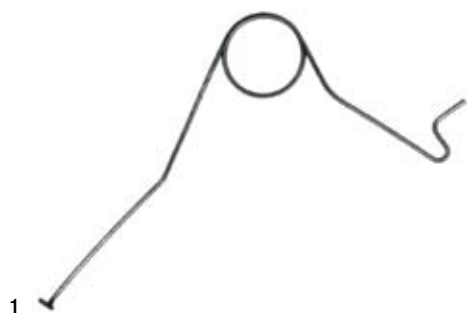

Línea AZUL

Nº	Referencia	Compatible con modelos	Ref. original
1	12 35037	365/371/372-Jonsered CS2172, CS2186, CS2063, CS2188, CS2165, CS2171,CS2071	503 73 64 01
2	12 35038	61/162/266/268/272. Jonsered 625, 630, 670	501 42 41 07

PALANCA DE FRENO (compatible con Husqvarna/Jonsered)



Nº	Referencia	Compatible con modelos	Ref. original
1	12 73006	340/345/350	503 85 09 01

Línea AZUL

PISTONES (compatible con Husqvarna/Jonsered)



Nº	Referencia	Compatible con modelos	Ref. original
1	12 44001	45/245R-RX. Jonsered GR44/RS44/2045 (42 mm)	503 44 10 02
	12 44002	51 (45 mm)	503 16 77 01
	12 44003	55. Jonsered 2054 (46 mm)	503 60 81 71
	12 44004	61. Jonsered 625 (48 mm)	544 22 38 02. Ref.Antigua: 503 53 90 02
	12 44005	266/268. Jonsered 670 (50 mm)	544 22 39 03. Ref.Antigua: 503 44 83 71
	12 44006	372. Jonsered 2071/2171 (50 mm)	503 93 92 71
	12 44007	357. Jonsered 2156 (46 mm)	537 21 96 02
	12 44008	365. Jonsered 2065/ 2165 (48 mm)	581 96 85 02. Ref. Antigua: 503 69 13 71
	12 44009	340. Jonsered 2141 (40 mm)	503 87 01 02. Ref. Antigua: 503 87 01 71
	12 44010	359. Jonsered 2159 (47 mm)	576 47 22 02. Ref.Antigua: 537 15 72 02
	12 44011	236/240E (39 mm)	545 08 18 94

Línea AZUL

PISTONES (compatible con Stihl)



2

Nº	Referencia	Compatible con modelos	Ref. original
2	12 44012	017 (37 mm)	1130 030 2000
	12 44013	021/023 (40 mm)	1123 030 2003
	12 44014	025 (42.5 mm)	1123 030 2011
	12 44015	026 (44 mm)	1121 030 2001
	12 44016	029/290 (46 mm)	1127 030 2003
	12 44017	039/390 (49 mm)	1127 030 2005
	12 44018	036 (48 mm)	1125 030 2001
	12 44019	038 (52 mm)	1119 030 2003
	12 44020	044 (50 mm). Bulón 12	1128 030 2001
	12 44021	046 (52 mm)	1128 030 2009
	12 44022	066 (54 mm)	1122 030 2005
	12 44023	MS 441 (50 mm)	1138 030 2003
	12 44024	MS 361 (47 mm)	1135 030 2000

Línea AZUL

POLEAS DE ARRANQUE (compatible con Alpina)



1

Nº	Referencia	Compatible con modelos	Ref. original
1	12 25001	330/380 Euro 35/Euro 40	4560840-4152100

Línea AZUL

POLEAS DE ARRANQUE (compatible con Husqvarna/Jonsered)

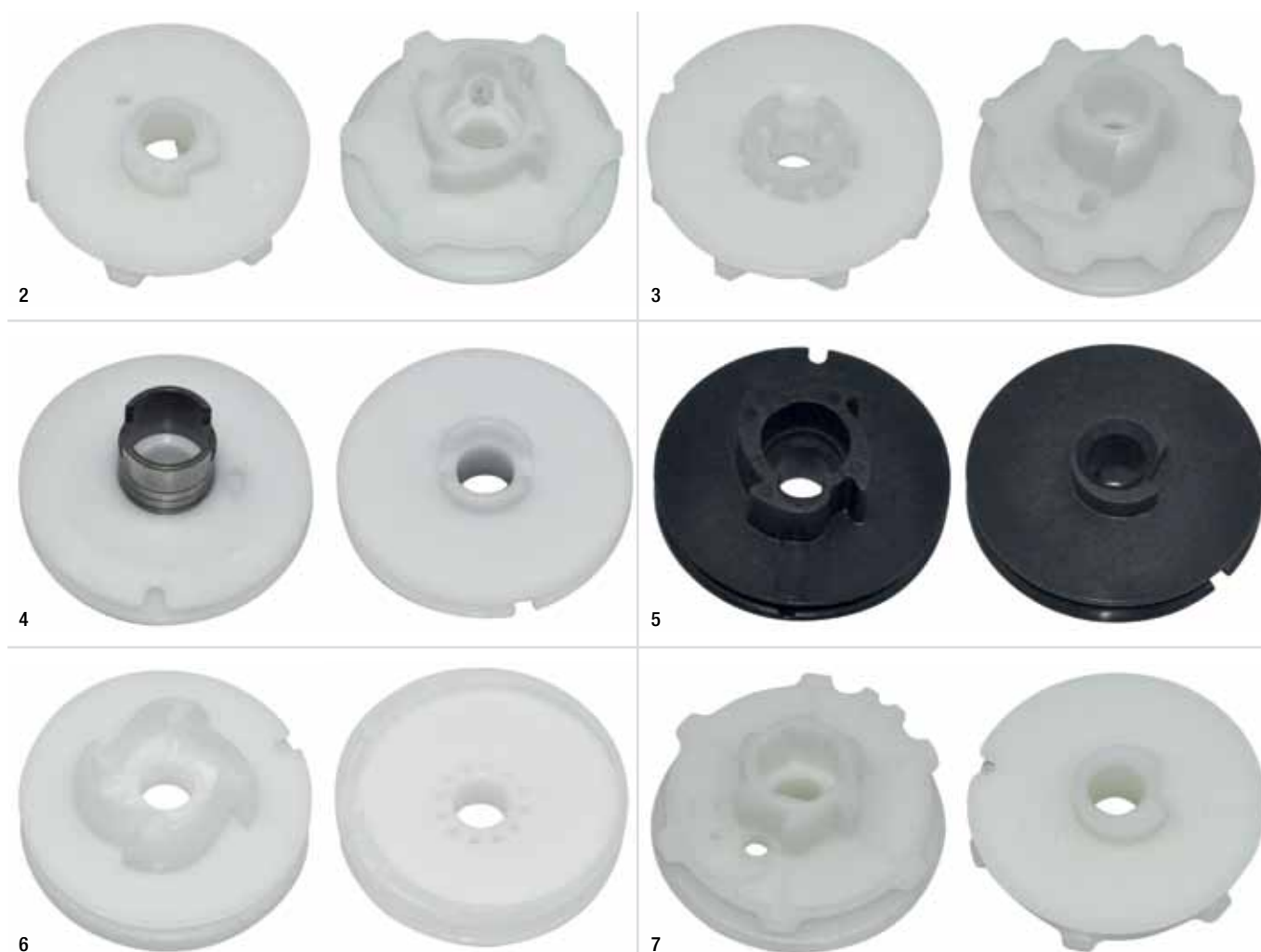

Nº	Referencia	Compatible con modelos	Ref. original
2	12 25002	40/45/240R/245R.	537 20 19 01 Ref.Antigua: 506 01 64 01
3	12 25003	235/236/240/ Partner P738/P740 /McCulloch Mac 738/ Mac 740.	530 05 78 90
4	12 25004	61/268/272. A partir de 1991	503 10 24 05
5	12 25005	50/51/55	505 30 37 35
6	12 25006	365/ 371/372. Jonsered 2171/2172	503 85 96 01
7	12 25007	36/41/136/141. Poulan 2250	530 06 93 13

Línea
AZUL

POLEAS DE ARRANQUE (compatible con Husqvarna/Jonsered)



8



9



10



Línea AZUL

Nº	Referencia	Compatible con modelos	Ref. original
8	12 25008	340/345/350. Jonsered 2149 Arranque fácil	537 42 33 01
9	12 25009	340/345/350. Jonsered 2150 Arranque fácil	537 42 32 01
10	12 25010	281/288	503 48 48 01

POLEAS DE ARRANQUE (compatible con Stihl)



11



12



13



14



Nº	Referencia	Compatible con modelos	Ref. original
11	12 25011	038/041/051/070/076	1117 007 1014
12	12 25012	036/044/046/MS360/MS361/MS440/MS461	1128 195 0400
13	12 25013	024/026/034/MS240/MS260/MS340	1125 195 0401
14	12 25014	017/018/019/021/023/025/MS180/MS190/MS230/MS250	1123 195 0400

Línea AZUL

RETENES CIGÜEÑAL (compatible con Husqvarna/Jonsered/Stihl)



1

Nº	Referencia	Compatible con modelos	Ref. original
1	12 43064	Husqvarna 61/268/K750 (15x26x6)	503 26 02 04
	12 43065	Husqvarna 55/357/365/372 (15x26x4)	505 27 57 19
	12 43066	Husqvarna 365/372 (18,4x26,4x3,6)	503 26 03 01
	12 43067	Husqvarna 288/395/950 (17x28x5)	503 26 02 05
	12 43068	Stihl 044/MS440 (18x29,6x5)	9640 003 1972
	12 43069	Stihl 044/MS440 (13x19x4)	9640 003 1320
	12 43070	Stihl 046/MS460/066/MS660 (13,5x20x4)	9640 003 1355
	12 43071	Stihl 026/028/036/046/MS261/MS361/MS460 (15x29,6x4)	9640 003 1600
	12 43072	Stihl 026/MS260/MS360 (15x20x5)	9640 003 1190
	12 43073	Stihl 038/MS380/MS381 (17x39.9x5)	9640 003 1880
	12 43074	Stihl 028/038/MS380/MS381 (13x22x5)	9640 003 1340
	12 43075	Stihl 066/MS660 (17x32.9x3.6)	9640 003 1850
	12 43076	Stihl 066/MS261/MS361/TS410 (15x22x4)	9640 003 1560
	12 43077	Stihl MS290/MS390 (17X30X4.4)	9639 003 1743
	12 43078	Stihl 025/MS170/MS250 (15X25X5)	9638 003 1581

Línea
AZUL

SEGMENTOS (compatible con Husqvarna/Jonsered/Stihl)



1

Nº	Referencia	Compatible con modelos	Ref. original
1	12 45001	Husqvarna 40 (40X1.5) (1PCS)	537 40 00 01. Ref.Antigua: 544 11 62 01/ 503 28 90 03
	12 45008	Husqvarna 345 (42X1.5) (1PCS)	503 28 90 05
	12 45002	Husqvarna 51 (45X1.5) (1PCS)	503 28 90 10
	12 45003	Husqvarna 55 (46X1.5) (1PCS)	503 28 90 14
	12 45004	Husqvarna 61/365 (48X1.5) (1PCS)	503 28 90 15
	12 45005	Husqvarna 268 (50X1.5) (1PCS)	503 28 90 17
	12 45007	Husqvarna 272 (52X1.5) (1PCS)	503 28 90 19
	12 45006	Husqvarna 288 (54X1.5) (1PCS)	544 22 51 01. Ref.Antigua: 503 28 90 22
	12 45010	Stihl 017 (37X1.2) (2PCS)	1130 034 3003
	12 45011	Stihl 018 (38X1.2) (2PCS)	1130 034 3002
	12 45012	Stihl 021/023 (40X1.2) (2PCS)	1123 034 3005
	12 45014	Stihl 024 (42X1.5) (2PCS)	1121 034 3005
	12 45013	Stihl 025 (42.5X1.2) (2PCS)	1123 034 3006
	12 45015	Stihl 026 (44X1.2) (2PCS)	1121 034 3002
	12 45021	Stihl 041 (44X1.5) (2PCS)	1110 034 3000
	12 45016	Stihl 026 (44.7X1.2) (2PCS)	1121 034 3010
	12 45017	Stihl 028/029/SR420/SR400/BR320 (46X1.5) (2PCS)	1118 034 3001
	12 45032	Stihl MS361 (47X1.2) (2PCS)	1135 034 3000
	12 45018	Stihl 036 (48X1.2) (2PCS)	1125 034 3001
	12 45020	Stihl 039 (49X1.5) (2PCS)	1127 034 3007
	12 45022	Stihl 044/MS441/TS410 (50X1.2) (2PCS)	1128 034 3000
	12 45023	Stihl 046 (52X1.2) (2PCS)	1122 034 3000
	12 45019	Stihl 038/051 (52X1.5) (2PCS)	1115 034 3010
	12 45024	Stihl 046/066 (54X1.2) (2PCS)	
	12 45027	Stihl 066 (56X1.2) (2PCS)	
	12 45028	Stihl 070/090 (58X1.5) (2PCS)	1106 034 3003

Línea
AZUL

Las referencias o alusiones a otras marcas hechas en el catálogo sólo son indicativas y sirven para la comprobación de nuestros productos. Suministramos SÓLO PIEZAS NO ORIGINALES.

SINFINES / PIÑONES DE ENGRASE

(compatible con Husqvarna/Jonsered)



1



2



3

NEW!



4

Nº	Referencia	Compatible con modelos	Ref. original
1	12 46001	61/162/268/272. Jonsered 625/ 630/ 670	501 51 38 01
2	12 46002	365/372. Jonsered 2065/2071 /2165/2172/	503 75 61 02/ 503 75 61 03
3	12 46003	357/359. Jonsered 2156/2159	503 91 27 03 (Ref. Antigua: 503 91 27 02)
4	12 46006	340-345	503 93 18 01

Linea
AZUL

SINFINES / PIÑONES DE ENGRASE (compatible con Stihl)



5



6



7

Nº	Referencia	Compatible con modelos	Ref. original
5	12 46008	026/MS260	1121 640 7111
6	12 46009	018/MS180/025/MS250	1123 640 7102
7	12 46010	029/039/MS290/MS390	1125 640 7110

Linea
AZUL

SINFINES / PIÑONES DE ENGRASE (compatible con Stihl)



Nº	Referencia	Compatible con modelos	Ref. original
8	12 46011	066/MS660	1122 640 7105
9	12 46012	044/046/MS440/MS460/MS361	1128 640 7112
10	12 46013	038/MS380/MS381	1119 640 7100

Linea AZUL

SOPORTE DE ESCAPE (compatible con Husqvarna/Jonsered)



Nº	Referencia	Compatible con modelos	Ref. original
1	12 51001	365/372/395. Jonsered CS2172, CS2186, CS2063, CS2188, CS2165, CS2171, CS2071	579 02 59 01
2	12 51002	61/268/272	503 53 59 01
3	12 51003	346/351/353	544 80 98 01

Linea AZUL

TAPAS DE CADENA (compatible con Stihl)



Nº	Referencia	Compatible con modelos	Ref. original
1	12 36014	038/MS380/MS381	1125 640 1701
2	12 36015	044/046/MS640/MS660	1122 648 0403
3	12 36016	017/018/021/023/025/MS170/MS180/MS210/MS230/MS250	1123 640 1705

Linea AZUL

TAPAS DE CADENA (compatible con Husqvarna/Jonsered)



Nº	Referencia	Compatible con modelos	Ref. original
4	12 36008	365/372	537 03 35 01
5	12 36009	340/345/350/351/357	537 10 78 01
6	12 36010	61/268/272	503 73 66 01
7	12 36011	136/137/141/142	530 05 48 02

Línea AZUL

TAPONES DE GASOLINA Y ACEITE (compatible con Oleo-Mac)



Nº	Referencia	Compatible con modelos	Ref. original
1	12 26005	Tapón de gasolina y aceite 936/937/940/941CX/947/953/GS370/GS410CX/GS350/GS940	50052005R

Línea AZUL

TAPONES DE GASOLINA Y ACEITE

(compatible con Husqvarna/Jonsered)



2

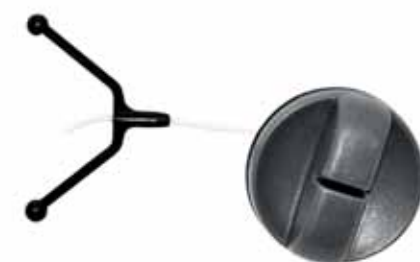

3



4



5



6



7



8

Nº	Referencia	Compatible con modelos	Ref. original
2	12 26061	Tapón gasolina y aceite 281/288/365/394/395/3120 Tapón de gasolina 42/50/51/55/340/345/346/350/351/353	537 21 52 02 537 21 52 02
3	12 26002	Tapón de gasolina 61/266/268/272	501 43 14 02
4	12 26003	Tapón de gasolina y aceite 235/236/240.	545 07 08 01
5	12 26004	Tapón gasolina y aceite 135/140/435/440/445/450/545/555/560/562	544 11 12 01
6	12 27001	Tapón de aceite 61/234/238/266/268/272	501 62 66 02 (Ref.Antigua: 501 62 66 01)
7	12 27002	Tapón de aceite 340/345/346XP/350/351/353 (Versión antigua)	537 28 15 02 (Ref.Antigua: 503 90 39 01)
8	12 27003	Tapón de aceite 51/55/136/137/141/142/254/257	501 76 56 02



Las referencias o alusiones a otras marcas hechas en el catálogo sólo son indicativas y sirven para la comprobación de nuestros productos. Suministramos SÓLO PIEZAS NO ORIGINALES.

TAPONES DE GASOLINA Y ACEITE (compatible con Partner)

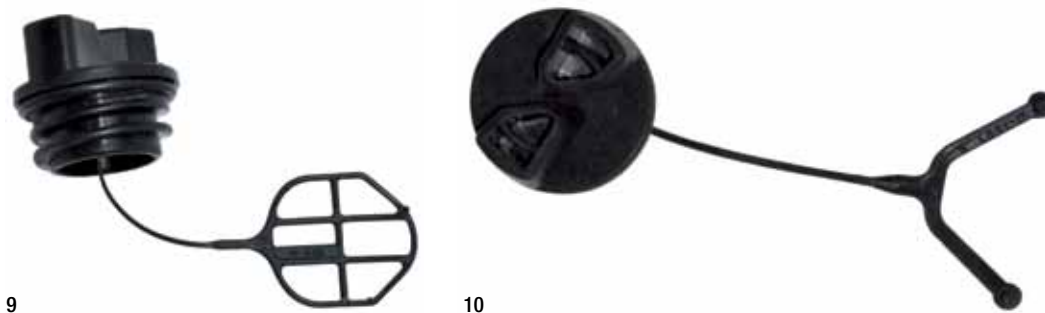

Nº Referencia	Compatible con modelos	Ref. original
9 12 26006	Tapón de gasolina 351/370/738/740/ McCulloch 738	577 85 85 01 Ref.Antigua: 530 04 71 92
10 12 27004	Tapón de aceite 350/351/371/ McCulloch Mac 438/442	530 01 08 46

Línea AZUL

TAPONES DE GASOLINA Y ACEITE (compatible con Stihl)



Nº Referencia	Compatible con modelos	Ref. original
11 12 26007	021/023/025/026/029/034/038/044/MS210/MS230/MS250/MS260/MS290/MS341/MS440/460 (Nueva versión)	0000 350 0525
12 12 26008	021/023/025/026/029/034/038/044/MS210/MS230/MS250/MS260/MS290/MS341/MS440/460 (Versión antigua)	0000 350 0500
13 12 26009	017/018/MS170/MS180	1130 350 0500
14 12 27005	026/029/036/038/039/044/046	0000 350 0520

Línea AZUL

TENSORES DE CADENA (compatible con Husqvarna/Jonsered)



Nº	Referencia	Compatible con modelos	Ref. original
1	12 55001	61/268/272/281/288. Jonsered 630/670	501 53 71 01
2	12 55002	51/55	501 54 63 01
3	12 55003	365/372/570/575	537 04 41 02

Línea AZUL

TENSORES DE CADENA (compatible con Oleo-Mac)



Nº	Referencia	Compatible con modelos	Ref. original
4	12 55005	947/952	50072027A
5	12 55006	941C/GS260/410CX	50162017A

Línea AZUL

Las referencias o alusiones a otras marcas hechas en el catálogo sólo son indicativas y sirven para la comprobación de nuestros productos. Suministramos SÓLO PIEZAS NO ORIGINALES.

TENSORES DE CADENA (compatible con Stihl)

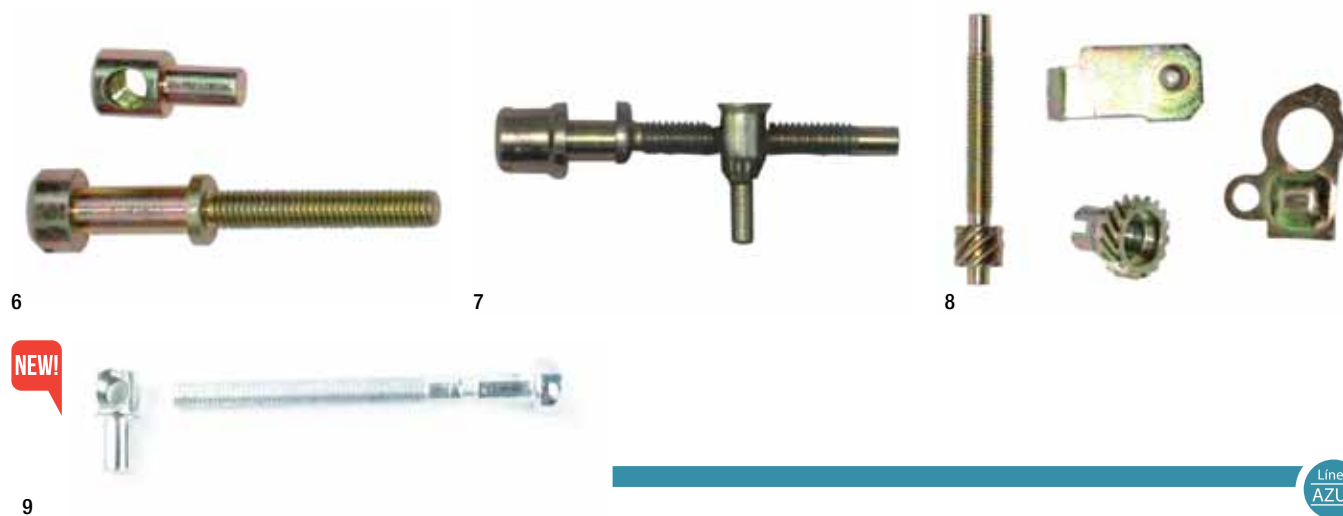

Nº	Referencia	Compatible con modelos	Ref. original
6	12 55007	038/MS380	1118 664 1600
7	12 55008	08/050/051/070/075/090	1106 664 1501
8	12 55009	Kit de tensor de cadena MS260/MS360/MS381/MS440/MS660	1125 007 1021
9	12 55010	021/023/025/MS180	1120 664 1502/ 1123 664 1605

TIRADORES DE AIRE (compatible con Husqvarna/Jonsered)



Nº	Referencia	Compatible con modelos	Ref. original
1	12 54001	51/55	503 60 84 02. Ref. Antigua: 503 60 84 01
2	12 54002	61/162/268/272/281/288	501 52 79 02
3	12 54003	365/372. Jonsered 2165/2171	503 62 77 01
4	12 54005	340/345/346/350/351/353	503 86 96 01
5	12 54006	357/359 (Leva)	503 94 54 01

TIRADORES DE AIRE (compatible con Stihl)



Nº	Referencia	Compatible con modelos	Ref. original
6	12 54007	MS341/MS361	1135 182 0900
7	12 54008	017/018/MS170/MS180	1130 182 0900
8	12 54009	MS210/MS230/MS250	1123 182 0901

Línea AZUL

TORNILLOS DE ESCAPE (compatible con Husqvarna/Jonsered)

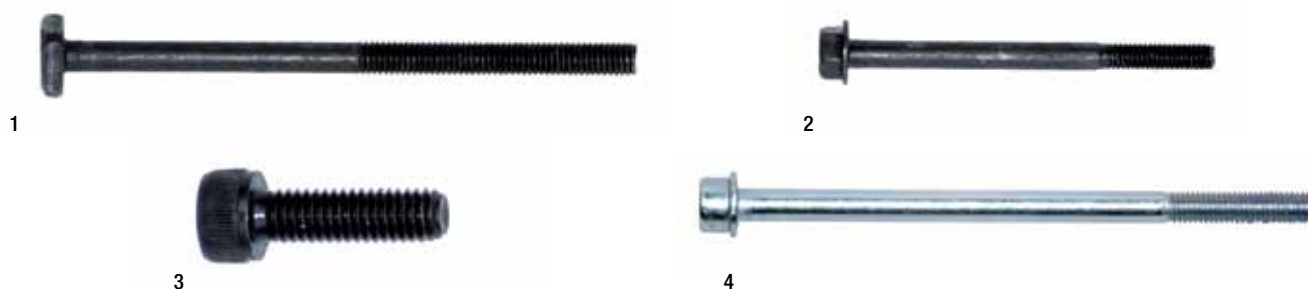

Nº	Referencia	Compatible con modelos	Ref. original
1	12 50001	50/51/55	503 21 82 02
2	12 50002	36/41/136/137/141/142	530 01 60 44
3	12 50003	362/365/371/372	725 53 70 55
4	12 50004	340/345/350	503 20 45 87

Línea AZUL

TORNILLOS DE ESCAPE (compatible con Stihl)



Nº	Referencia	Compatible con modelos	Ref. original
5	12 50005	017/018/021/MS170/MS210/MS230/MS250 (M5X65)	1123 148 1201

Línea AZUL

TRINQUETES (compatible con Husqvarna/Jonsered)



Nº	Referencia	Compatible con modelos	Ref. original
1	12 58001	61/262/268/281/288/395/265RX/356BTX... Para distintos modelos de motosierras, desbrozadores y sopladores	501 67 32 01
2	12 58008	Kit trinquete + muelle 61/262/268/281/288/395/265RX/356BTX... Para distintos modelos de motosierras, desbrozadores y sopladores	501 67 32 01 / 501 67 35 01
3	12 58002	365/372	503 85 95 01
4	12 58004	340/345/346/350/351/353	503 89 50 01

Línea AZUL

TRINQUETES (compatible con Stihl)



Nº	Referencia	Compatible con modelos	Ref. original
5	12 58005	038/070	1124 195 7200
6	12 58006	025/029/036/044/046/MS361	1125 195 7200
7	12 58007	MS240/MS260/290/310/340/360/390/440/460	1125 195 7200 / 0000 958 0923 / 1118 195 3500

Línea AZUL

TUBO IMPULSIÓN (compatible con Husqvarna/Jonsered)



1

Nº Referencia	Compatible con modelos	Ref. original
1 12 65001	Husqvarna 136/137/141/142 Jonsered 2036/2040	530 05 34 35

Línea AZUL

TUBO IMPULSIÓN (compatible con Stihl)



2



3



4

Nº Referencia	Compatible con modelos	Ref. original
2 12 65002	Stihl MS440/MS660	1128 141 8600
3 12 65003	Stihl 021/MS210/MS230/MS250	1123 141 8600
4 12 65004	Stihl 029/039/MS290/MS310/MS390/MS640	1127 141 8600

Línea AZUL

TUBOS DE ASPIRACIÓN DE ACEITE

(compatible con Husqvarna/Jonsered)



1

Nº Referencia	Compatible con modelos	Ref. original
1 12 64001	Husqvarna 365/372	503 42 67 01

Línea AZUL

TUBOS DE ASPIRACIÓN DE ACEITE (compatible con Oleo-Mac)



2



3

Nº Referencia	Compatible con modelos	Ref. original
2 12 64002	Oleo-Mac 947/952	500 700 54
3 12 64003	Oleo-Mac 956/962	500 100 60

Línea AZUL

TUBOS DE ASPIRACIÓN DE ACEITE (compatible con Stihl)

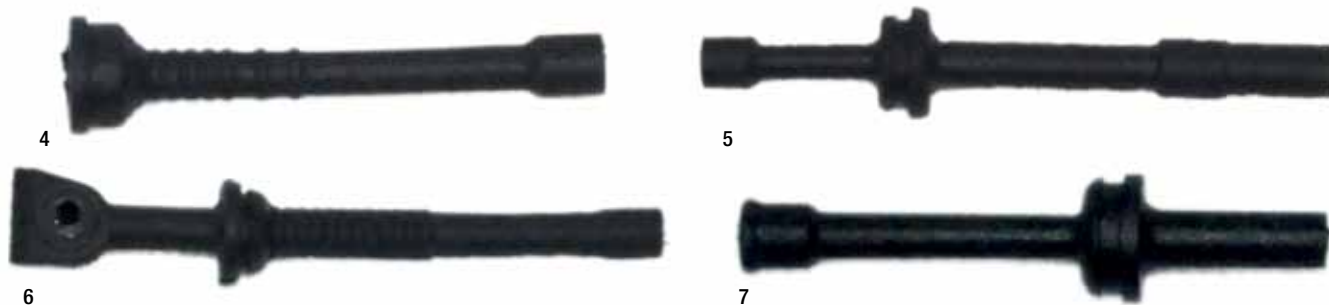

Nº	Referencia	Compatible con modelos	Ref. original
4	12 64004	Stihl 021/023/025/MS210/MS230/MS250	1123 647 9400
5	12 64005	Stihl 029/038/039/MS290/MS380	1127 647 9400
6	12 64006	Stihl 017/018/MS170/MS180	1130 647 9400
7	12 64007	MS270/MS280	1133 647 9400

Línea AZUL

TUBOS DE GASOLINA (compatible con Husqvarna/Jonsered)



Nº	Referencia	Compatible con modelos	Ref. original
1	12 28005	Compatible todos los modelos (30 cm) (Interior:2,5mm, Exterior: 5 mm)	581 75 62 02 Referencias antiguas 503 57 76 02; 544 32 50 02
2	12 28006	Compatible todos los modelos (25 cm) (Interior:2,5mm, Exterior: 5 mm)	581 75 62 01 Referencias antiguas 503 57 76 01; 544 32 50 01

Línea AZUL

TUBOS DE GASOLINA (compatible con Stihl)



Nº	Referencia	Compatible con modelos	Ref. original
3	12 28007	034/036/038/064/MS380	1119 358 7701
4	12 28008	044/046/MS440/MS460/MS361	1128 358 7701

TUERCAS DE CADENA

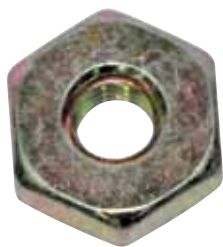

1



2

Nº	Referencia	Compatible con modelos	Ref. original
1	12 38001	Tuerca de 19 mm compatible con modelos 026/038/044/066 Husqvarna, Alpina, OleoMac,...	0000 955 0801
2	12 38002	Tuerca 13 mm compatible con Husqvarna, Alpina, Efco, OleoMac, Dolmar, Makita, Stiga	503 22 00 01

Línea AZUL

VÁLVULAS DE DESCOMPRESIÓN

(compatible con Husqvarna/Jonsered/Stihl)



1



2

Nº	Referencia	Compatible con modelos	Ref. original
1	12 29004	Husqvarna. Válvula de descompresión compatible con todos Husqvarna	503 71 53 01
2	12 29005	Stihl. Válvula de descompresión compatible con todos los Stihl	1123 020 9400

Línea AZUL

VOLANTES DE INERCIA (compatible con Husqvarna/Jonsered)



1



2

Nº	Referencia	Compatible con modelos	Ref. original
1	12 16011	365/372. Jonsered 2165/2171	537 05 16 05
2	12 16012	61/261/268	537 05 16 02

ACCESORIOS DESBROZADORAS



KURITA®

BAYGAR

NYLON KURIL SERIE PROFESIONAL. MÁXIMO RENDIMIENTO



Nº	Referencia	Descripción	Tipo
1	47 78005	Nylon redondo 15m-1,6mm.	Redondo
1	47 78006	Nylon redondo 15m-2,4mm.	Redondo
1	47 78007	Nylon redondo 90m-2,4mm.	Redondo
1	47 78008	Nylon redondo 15m-3mm.	Redondo
1	47 78009	Nylon redondo 60m-3mm.	Redondo
1	47 78010	Nylon redondo 180m-3mm.	Redondo
1	47 78011	Nylon redondo 45m-3,3mm.	Redondo
1	47 78012	Nylon cuadrado 90m-2,4mm.	Cuadrado
1	47 78013	Nylon cuadrado 60m-3mm.	Cuadrado
1	47 78014	Nylon cuadrado 132m-3mm.	Cuadrado
1	47 78015	Nylon dentado 37m-3mm.	Dentado
1	47 78016	Nylon dentado 27m-3,5m.	Dentado
1	47 78017	Nylon dentado 21m-4mm.	Dentado
1	47 78018	Nylon trenzado 15m-2,4mm.	Trenzado
1	47 78019	Nylon trenzado 35m-2,4mm.	Trenzado
1	47 78020	Nylon trenzado 70m-2,4mm.	Trenzado
1	47 78021	Nylon trenzado 15m-3mm.	Trenzado
1	47 78022	Nylon trenzado 43m-3mm.	Trenzado
1	47 78023	Nylon trenzado 37m-3,3mm.	Trenzado
1	47 78024	Nylon trenzado 26m-4mm.	Trenzado
2	47 K50719018	Hilo desbrozadora pre-cortado Blister nylon 300x3,0 mm (25 uds)	Cuadrado
2	47 K50719019	Hilo desbrozadora pre-cortado Blister nylon 300x3,3 mm (25 uds)	Cuadrado

Línea AZUL

Redondo: Máximo rendimiento en jardinería.

Cuadrado: Máximo rendimiento en jardinería.

Dentado: Diente tiburón. Ideal para trimmys multihilos.

Trenzado: Nylón profesional de máxima resistencia. Condiciones extremas.

NYLON DENTADO



1

Nº	Referencia	Descripción	Tipo
1	47 05200115	Rollo nylon dentado 37m-3mm	Dentado
	47 05200116	Rollo nylon dentado 27m-3,5mm	Dentado
	47 05200117	Rollo nylon dentado 21m-4mm	Dentado
	47 05200118	Rollo nylon dentado 16m-4,5mm	Dentado

Línea AZUL

NYLON SARP



1



2



3

Nº	Referencia	Descripción	Tipo
1	47 CAN16	Rollo nylon sarp 15m. - 1,6mm. Azul	Redondo
1	47 CAN24	Rollo nylon sarp 15m. - 2,4mm. Verde	Redondo
1	47 CAN3	Rollo nylon sarp 15m. - 3mm. Blanco	Redondo
2	47 NYG	Rollo nylon sarp 60m. - 3mm. Verde	Redondo
2	47 NYS	Rollo nylon sarp 45m. - 3,3mm. Verde	Redondo
2	47 NYP	Rollo nylon 60mx3mm. Naranja	Cuadrado
2	47 NYE	Rollo nylon sarp 90m. - 2,4mm. Verde	Redondo
2	47 NYM	Rollo nylon 90mx2,4mm. Naranja	Cuadrado
2	47 AL241	Rollo nylon sarp 90m 2,4mm. Aluminio	Cuadrado
2	47 AL301	Rollo nylon sarp 60m 3mm. Aluminio	Cuadrado
3	47 NYH	Rollo nylon sarp 180m.- 3mm. Verde	Redondo
3	47 NYF	Rollo nylon sarp 270m.- 2,4mm. Verde	Redondo
3	47 AL303	Rollo nylon sarp 132m 3mm. Aluminio	Cuadrado

Línea AZUL

DISCOS WIDEA



Nº	Referencia	Descripción
1	78 LCL3M04014	Disco widea 250x25,4x2,8mm
1	78 LCL3M04010	Disco widea 250x20,0x2,8mm
2	78 77005	Disco widea 255x25,4x2mm. 40 dientes. Incluye arancela de reducción 20 mm
3	78 77008	Arandela reductora de disco de 25,4 mm a 20 mm. Grosor: 1,25 mm

Línea AZUL

DISCOS DESBROZADORA

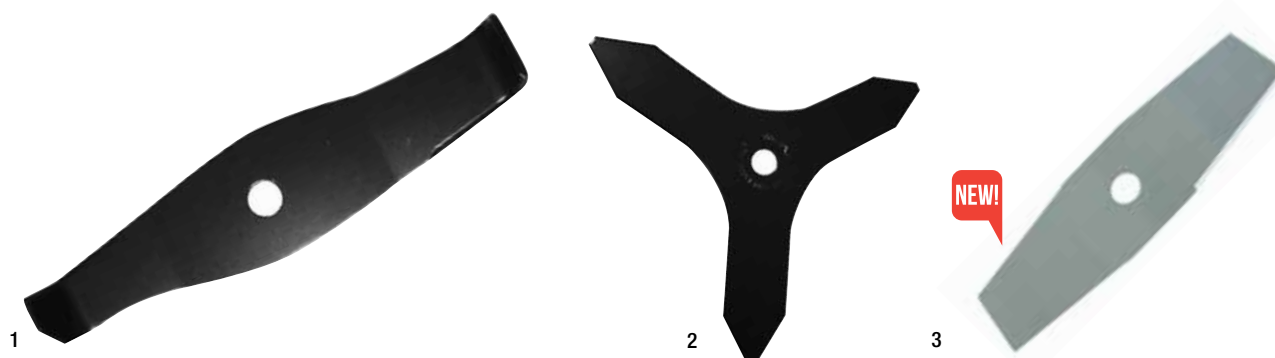

Nº	Referencia	Descripción
1	78 320202T	Cuchilla triturar 320x20x4mm (caja 20 uds) KURIL
1	78 3202542T	Cuchilla triturar 320x25.4x4mm (caja 20 uds) KURIL
1	78 300202T	Cuchilla triturar 300x20x3mm (caja 20 uds) KURIL
1	78 3002542T	Cuchilla triturar 300x25.4x3mm (caja 20 uds) KURIL
2	78 350203T	Cuchilla 3p 350x20x4mm (caja 25 uds) KURIL
2	78 3502543T	Cuchilla 3p 350x25.4x4mm (caja 25 uds) KURIL
2	78 300203T	Cuchilla 3p 300x20x3mm (caja 25 uds) KURIL
2	78 3002543T	Cuchilla 3p 300x25.4x3mm (caja 25 uds) KURIL
2	78 300203T4	Cuchilla 3p 300x20x4mm (caja 25 uds) KURIL
2	78 3002543T4	Cuchilla 3p 300x25.4x4mm (caja 25 uds) KURIL
3	78 77001	Disco plano 2 puntas 305 x 20 x 90 x 3mm KURIL
3	78 77002	Disco plano 2 puntas 305 x 20 x 90 x 4mm KURIL
3	78 77003	Disco plano 2 puntas 305 x 25.4 x 90 x 3mm KURIL
3	78 77004	Disco plano 2 puntas 305 x 25.4 x 90 x 4mm KURIL

Línea AZUL

Las referencias o alusiones a otras marcas hechas en el catálogo sólo son indicativas y sirven para la comprobación de nuestros productos. Suministramos SÓLO PIEZAS NO ORIGINALES.

PROTECTORES DISCOS DESBROZADORA



1

NEW!



2



3



4

Nº	Referencia	Descripción
1	47 5110901	Protector plastico d.24-26-28
2	78 70002	Protector disco desbrozadora Plástico d.24-26-28. KURIL
3	47 5100902	Protector metalico d.24-26-28
4	47 5100901	Protector metalico d.24-26-28

Línea AZUL

ARNÉS DESBROZADORA



1

NEW!



2

Nº	Referencia	Descripción
1	78 KUKH1	Arnés Estándar
2	78 60006	Arnés profesional

Línea AZUL

CAZOLETAS



1



2

Nº	Referencia	Descripción
1	78 39001	Cazoleta Kuril 8 mm D.85 x d.8 x H.18 mm
1	78 39002	Cazoleta Kuril 10 mm D.85 x d.10 x H.18 mm
2	78 39003	Cazoleta Kuril 12 mm D.85 x d.12 x H.25 mm

CABEZALES NYLON



1



2



3



4



5

NEW!



6

NEW!



7



9

NEW!



8



10

Nº	Referencia	Descripción
1	47 5030913	Cabezal hilo manual 10x125 hembra
1	47 5030917	Trimmer manual 12x150 hembra
2	47 50709012	Cabezal M10x125 hembra
2	47 50709014	Cabezal hilo 12x150 hembra
2	47 5070911	Trimmer semi automatico universal
3	47 50709015	Cabezal 10x125 carga rapida
3	47 50709034	Cabezal 12x150 carga rapida
3	47 50709056	Cabezal universal carga rapida
4	47 50909006	Cabezal de aluminio multihilos 4 hilos. Universal
4	47 5090911	Cabezal de aluminio multihilos 8 hilos. Universal
5	78 70000	Cabezal trimmy T35 semi-automático. Incluye los siguientes adaptadores: 8x125M/10x125M/ 8X125F/10X125F/10X150F/ 12X150F/12X175F
6	78 70001	Cabezal trimmy universal T45 semi-automático Incluye los siguientes adaptadores: 8x125M/10x125M/ 8X125F/10X125F/10X150F/12X150F/12X175F
7	78 70003	Cabezal semi-automático. 10x150 hembra
8	78 70004	Cabezal semi-automático. 10x125 hembra. Carga rápida
9	78 70005	Cabezal multihilos universal. Incluye llave hexagonal y adaptadores. Ajuste lateral
10	78 70006	Cabezal multihilos universal. Incluye llave hexagonal y adaptadores. Ajuste en la parte de abajo

Las referencias o alusiones a otras marcas hechas en el catálogo sólo son indicativas y sirven para la comprobación de nuestros productos. Suministramos SÓLO PIEZAS NO ORIGINALES.

ADAPTADORES PARA CABEZAL

(Adaptable a los cabezales de la figura 2, 3, 7 y 8)

NEW!



1

NEW!



2

Nº	Referencia	Descripción
1	78 70007	Adaptador macho 8 x 1,25 x 10 x 1,25
1	78 70008	Adaptador macho 10 x 1,25 x 10 x 1,25
2	78 70009	Adaptador femia 8 x 1,25
2	78 70010	Adaptador femia 10 x 1,25
2	78 70011	Adaptador femia 10 x 1,00
2	78 70012	Adaptador femia 10 x 1,50
2	78 70013	Adaptador femia 12 x 1,75
2	78 70014	Adaptador femia 12 x 1,50

Línea AZUL

ACCESORIOS DESBROZADORA VARIOS



1



2

Nº	Referencia	Descripción
1	78 99100110	Codo de desbrozadora universal para adaptador. Para tubos de 24-25-25,4-26-28 mm
2	78 99100111A	Adaptador codo-estrellado 9 dientes
2	78 99100111B	Adaptador codo-estrellado 8 dientes
2	78 99100111C	Adaptador codo-estrellado 7 dientes
2	78 99100111D	NEW! Adaptador codo Stihl 6.5 mm
2	78 99100111E	NEW! Adaptador codo Stihl 5.5 mm
2	78 99100111F	Adaptador codo-estrellado 10 dientes
2	78 99100111G	Adaptador codo-cuadrado 6 mm
2	78 99100111H	Adaptador codo-cuadrado 5,4 mm
1	78 70021	Codo de desbrozadora universal fijo. 26 mm - 7 estrías
1	78 70022	Codo de desbrozadora universal fijo. 26 mm- 9 estrías
1	78 70023	Codo de desbrozadora universal fijo. 28 mm- 7 estrías
1	78 70024	Codo de desbrozadora universal fijo. 28 mm- 9 estrías

Línea AZUL

BARRA DESBROZADORA

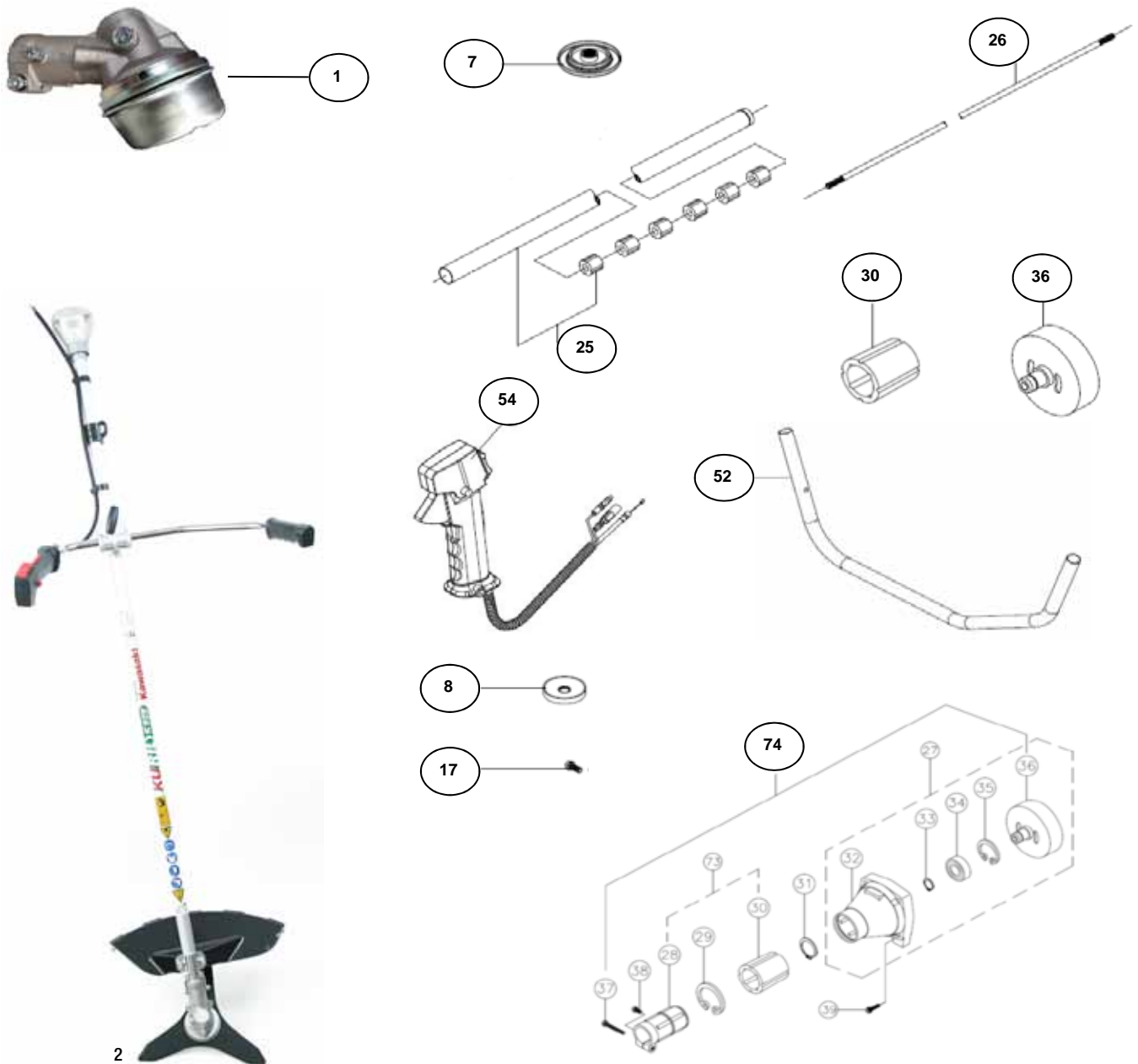

N.º Referencia	Descripción
78 2724L	Barra desbrozadora Kuril completa. 24 mm- Asa (Unidades limitadas)
2 78 K828	Barra desbrozadora Kuril completa. 28 mm-Manillar
1 63 TJ002805	Codo Completo (28mm 9 estrias)
7 63 BJ092801T	Arandela Codo
8 63 BJ082803	Arandela Codo
17 63 XGW88	Tapon Grasa M8x8
25 63 TK145816282	Tubo 28X1500mm
26 63 BK0481540	Eje Transmission 8X1540 Mm 9 Estrias
30 63 BG072501	Amortiguador
36 63 TG12035	Campana Embrague
52 63 BH013201	Manillar 19 Mm
54 63 AE31901TH48	Mando Gas Completo 19 Mm
74 63 TG25078	Conjunto Soporte Campana 9 Estrias

Las referencias o alusiones a otras marcas hechas en el catálogo sólo son indicativas y sirven para la comprobación de nuestros productos. Suministramos SÓLO PIEZAS NO ORIGINALES.

RECAMBIOS DESBROZADORAS



KURITA®

BAYGAR

BOBINAS DE ENCENDIDO (compatible con Husqvarna/Jonsered)



Nº	Referencia	Compatible con modelos	Ref. original
1	12 16001	240R/245R/250R/252R/50/51/55/154/254/262/257. Jonsered RS44/GR41/GR50	544 01 83 01 (Reemplaza 503 90 12 01)
2	12 16014	232R/235R/235R11 (Versión antigua). Jonsered GR2026/GR2032/GR2036	537 03 85 01
3	12 16015	323R/325R/326R/326RX	503 13 85 01
4	12 16016	555FX/555FXT/355FX/355FXT. Jonsered 2255/2256	576 44 52 01 (Reemplaza 504 70 87 01)
5	12 16017	125R/128R. Jonsered GC2126/GC2128	545 04 67 01

Línea AZUL

BOBINAS DE ENCENDIDO (compatible con Kawasaki)



Nº	Referencia	Compatible con modelos	Ref. original
6	12 16018	TD33-40-48. Distancia entre tornillos: 62,5	21171-2192

Línea AZUL

BOBINAS DE ENCENDIDO (compatible con Oleo-Mac)



Nº	Referencia	Compatible con modelos	Ref. original
7	12 16022	Sparta 37/38/42/44/370/ 380T/440T	61250015BR

Línea AZUL

BOBINAS DE ENCENDIDO (compatible con Mitsubishi)



NEW!

8



NEW!

9



NEW!

10

Nº	Referencia	Compatible con modelos
8	12 16019	TL26
9	12 16020	TL43, Kubota
10	12 16021	TL33/TL43/TL52

Línea AZUL

BOBINAS DE ENCENDIDO (compatible con Stihl)



11

Nº	Referencia	Compatible con modelos	Ref. original
11	12 16023	FS120/FS200/FS250/ FS300/FS350/FS400	4134 400 1301

Línea AZUL

CABLES ACELERADOR (compatible con Husqvarna/Jonsered)



NEW!

1



NEW!

2



NEW!

3



NEW!

4

Nº	Referencia	Compatible con modelos	Ref. original
1	12 35017	132R	531 00 78 81
2	12 35018	232R-235R. Juego de cables	502 20 69 01
3	12 35019	235R. Solo cable de gas. Largo: 931 mm.	502 18 98 01
4	12 35020	142R. Largo: 878 mm.	531 00 78 82

Línea AZUL

CABLES ACELERADOR (compatible con Stihl)

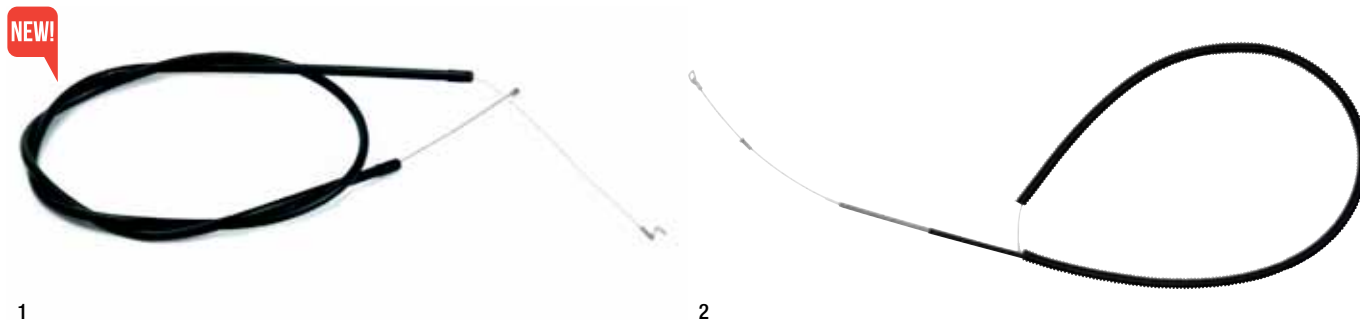

Nº	Referencia	Compatible con modelos	Ref. original
5	12 35021	FS220	4119 180 1101
6	12 35022	FS400/FS450/FS480	4128 180 1102

Línea AZUL

CAMPANA DE EMBRAGUE (compatible con Solo)



Nº	Referencia	Compatible con modelos	Ref. original
1	12 18029	154	3500136
2	12 18030	133/143/148/1425B/1545B	

Línea AZUL

CAPOT (GANCHO CAPOT) (compatible con Husqvarna/Jonsered)



Nº	Referencia	Compatible con modelos	Ref. original
1	12 72005	345/355/535/543/545/553/555/365/372/385/390 (grapa capot)	503 74 01 02

Línea AZUL

CAPUCHONES DE BUJÍA (compatible con Husqvarna/Jonsered)



1

Nº	Referencia	Compatible con modelos	Ref. original
1	12 14001	5/7 mm	501 48 54 02

Línea AZUL

CAPUCHONES DE BUJÍA (compatible con Stihl)



2

Nº	Referencia	Compatible con modelos	Ref. original
2	12 14002	Capuchón compatible con modelos 026/036/038/044/046/066	1128 405 1000

Línea AZUL

CARBURADORES (compatible con Honda)



1

Nº	Referencia	Compatible con modelos	Ref. original
1	12 30026	GX35 (desbrozadoras)	16100-Z0Z-813 16100-Z0Z-814

Línea AZUL

CARBURADORES (compatible con Kawasaki)



2

Nº	Referencia	Compatible con modelos	Ref. original
2	12 30028	TJ 45E (Walbro WYA-169)	15004-2060

Línea AZUL

CARBURADORES (compatible con Husqvarna/Jonsered)



Nº	Referencia	Compatible con modelos	Ref. original
3	12 30027	Zama compatible 343R/345R. Jonsered FC 2145/ BC 2145	C1Q-EL22/ 503 28 31 16 Ref. Ant: 503 28 31 17
4	12 30012	Walbro WT-99. Husqvarna 40/45/240R/245R/245RX	WT-99/503 28 13 20
5	12 30030	Zama C1Q-EL12. Husqvarna 325R/323R/326R	C1Q-EL12/503 28 34 01 Ref. Antigua: 503 28 31 11



CARBURADORES (compatible con Partner)



Nº	Referencia	Compatible con modelos	Ref. original
7	12 30029	Walbro WT-631. Partner Colibri	WT-631 530 07 16 35 Ref. Antigua: 530 06 99 71



CARBURADORES (compatible con Solo)



Nº	Referencia	Compatible con modelos	Ref. original
8	12 30031	Walbro HDA-155. Solo 134/137/140	2300777



Las referencias o alusiones a otras marcas hechas en el catálogo sólo son indicativas y sirven para la comprobación de nuestros productos. Suministramos SÓLO PIEZAS NO ORIGINALES.

CEBADORES / BOMBINES DE CARBURADOR (Universal)



Nº	Referencia	Compatible con modelos	Ref. original
1	12 29001	Universal	
2	12 29002	Walbro. WT/ WY/ WYJ/ WYK/ WYP/ WZ. Kawasaki TJ	W 188-12
3	12 29003	Walbro. HDA/ WYK. Kawasaki TH	W 188-13

Línea AZUL

CIGÜEÑALES (compatible con Husqvarna/Jonsered)



Nº	Referencia	Compatible con modelos	Ref. original
1	12 37001	40/45/51/55/240R/245R. Jonsered 2041/2045/2050/GR41/GR50/RS44	503 57 38 06
2	12 37002	250R/250RX/252RX	502 05 08 74

Línea AZUL

CONJUNTOS DE ARRANQUE (compatible con Stihl)



Nº	Referencia	Compatible con modelos	Ref. original
1	12 41024	FS160/220/280	4119 190 0401

CONJUNTOS DE ARRANQUE (compatible con Honda)

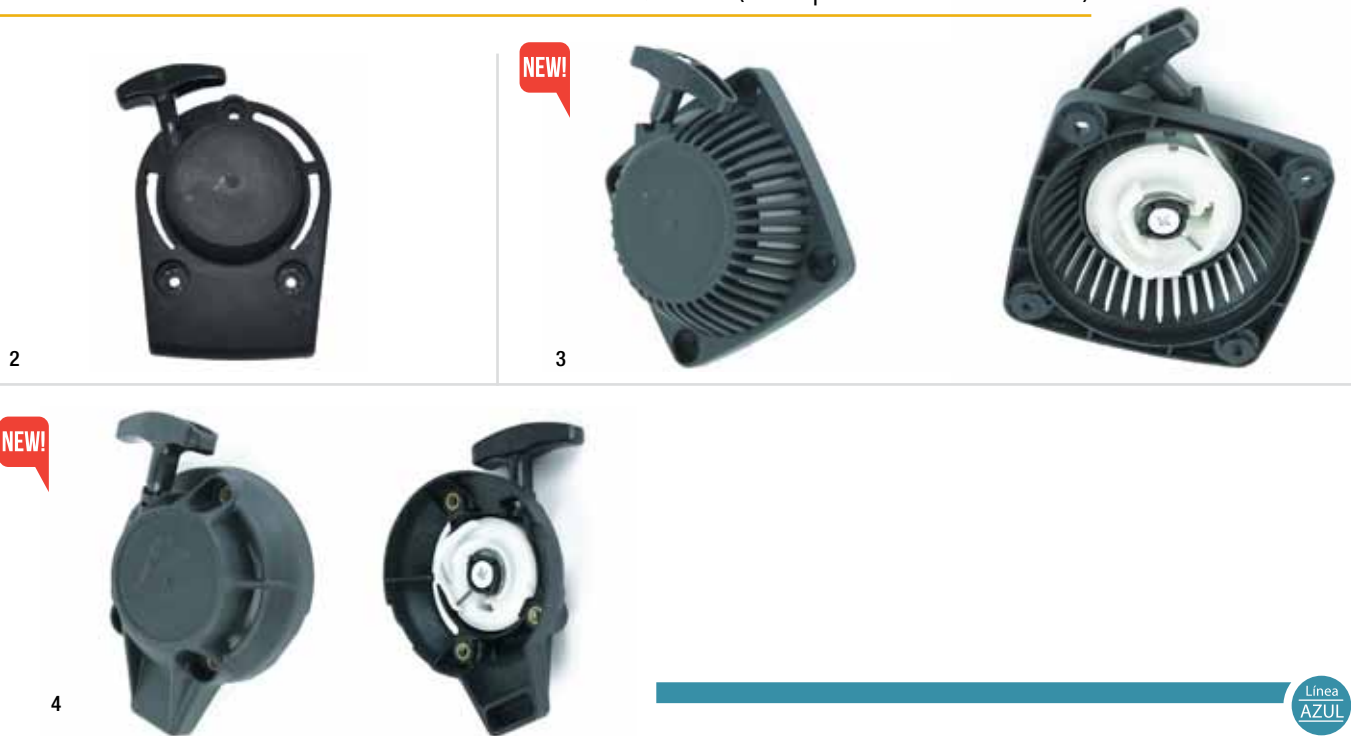

Nº	Referencia	Compatible con modelos	Ref. original
2	12 41018	GX35 (desbrozadora)	28400-ZOZ-003
3	12 41019	4 Tiempos. GX22 / GX31 / GX34 (4 tornillos)	28400-ZM3-003
4	12 41026	4 Tiempos. GX22 / GX31 / GX34 (3 tornillos)	

Línea AZUL

CONJUNTOS DE ARRANQUE (compatible con Kawasaki)



Nº	Referencia	Compatible con modelos	Ref. original
5	12 41020	TH43/TH48	49088-2442
6	12 41027	TJ45E	49088-0016
7	12 41028	TD40D	49088-2166

Línea AZUL

CONJUNTOS DE ARRANQUE (compatible con Mitsubishi)

NEW!



8

NEW!



9

NEW!



10

Nº	Referencia	Compatible con modelos	Ref. original
8	12 41021	TL26	TL26, TU26
9	12 41022	TL43/52	KS20037AA
10	12 41023	TL43/52 (Modelo moderno)	TL43N

Línea AZUL

CONJUNTOS DE ARRANQUE (compatible con Zenoah/Komatzu)

NEW!



11

Nº	Referencia	Compatible con modelos
11	12 41029	Zenoah/Komatzu

EJE TRANSMISIÓN

NEW!

1

Nº	Referencia	Compatible con modelos
1	12 70015	Eje transmisión 154 cm 7 estrías 8mm
	12 70016	Eje transmisión 155 cm 7 estrías 8mm
	12 70017	Eje transmisión 152 cm 9 estrías 8mm
	12 70018	Eje transmisión 154 cm 9 estrías 8mm
	12 70019	Eje transmisión 156 cm 9 estrías 8mm
	12 70020	Eje transmisión 159 cm 9 estrías 8mm

Línea AZUL

EMBRAGUES (compatible con Kawasaki)



1

Nº	Referencia	Compatible con modelos	Ref. original
1	12 17016	TD 33/40/48-TH 43/48 TJ45	13081-2220 13081-2221

Línea AZUL

EMBRAGUES (compatible con Robin)

NEW!



2

Nº	Referencia	Compatible con modelos	Ref. original
2	12 17019	NB-411 (Diámetro interior: 11,50 mm; diámetro exterior: 75 mm)	

Línea AZUL

EMBRAGUES (compatible con Stihl)



3

Nº	Referencia	Compatible con modelos	Ref. original
3	12 17020	FS160/180/220/280 (Diámetro 6,1mm)	4119 160 2000

Línea AZUL

EMBRAGUES (compatible con Mitsubishi)



4



5

Nº Referencia	Compatible con modelos
4 12 17017	TL26-Tanaka TBC250-Echo (Diámetro interior: 8 mm; diámetro exterior: 52 mm)
5 12 17018	TL43/52 (Diámetro interior: 10 mm; diámetro exterior: 76 mm)

Línea
AZUL

EMBRAGUES (compatible con Maruyama)



6

Nº Referencia	Compatible con modelos
6 12 17021	BC420-500

Línea
AZUL

ESCAPES (compatible con Mitsubishi)



1



2

Nº Referencia	Compatible con modelos	Ref. original
1 12 49015	TL33	KM01040GA
2 12 49016	TL43	KM01037AA

Línea
AZUL

FILTROS DE AIRE (compatible con Alpina)

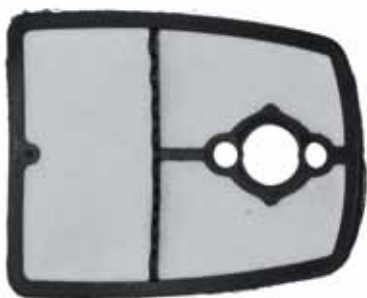

1

Nº Referencia	Compatible con modelos	Ref. original
1 12 10041	Stiga SB 44/Star 45 / Alpina SB44/Star 45,55	378164

Línea
AZUL

FILTROS DE AIRE (compatible con Husqvarna/Jonsered)



2



3



4



5



6

Nº Referencia	Compatible con modelos	Ref. original
2 12 10042	235R/ 225 HD/232R/232L/ 227L/ 227R/Jonsered/Partner	502 19 86-02
3 12 10043	39R/240R/245R/245RX	502 11 58 01
4 12 10044	250R/252 RX	502 22 59 01
5 12 10045	323-325-326 L/LD/LDX/R/RX/RJ	537 18 63-01
6 12 10046	343R/345R/345RX/545/545RX/555RX/FRM/R (Medidas en mm: 83x94x121)	574 66 80-01

Línea
AZUL

Las referencias o alusiones a otras marcas hechas en el catálogo sólo son indicativas y sirven para la comprobación de nuestros productos. Suministramos SÓLO PIEZAS NO ORIGINALES.

FILTROS DE AIRE (compatible con Mitsubishi)



Nº	Referencia	Compatible con modelos	Ref. original
7	12 10047	TL50	
8	12 10048	TL50 (Tapa filtro)	

Línea AZUL

FILTROS DE AIRE (compatible con Oleo-Mac)



Nº	Referencia	Compatible con modelos	Ref. original
9	12 10049	746/753/755 Master/Efco 8460,8550 (Medidas en mm: 90x64x25)	611 20018
10	12 10050	Sparta 37/38/42/44; 370S/T, 380S/T, 440 S/T	612 00025AR

Línea AZUL

FILTRO DE AIRE (compatible con Kawasaki)

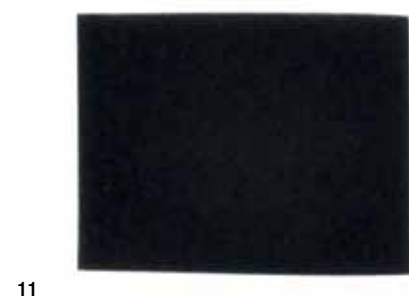

Nº	Referencia	Compatible con modelos	Ref. original
11	12 10104	TH43	11013-2084

FILTROS DE AIRE (compatible con Stihl)



12



13



14



15



16

Nº	Referencia	Compatible con modelos	Ref. original
12	12 10051	FS 200/250/350/400/450 (Medidas en mm: 83x62x23)	4134 141 0300
13	12 10052	FS 87/100/130/310 (Desbrozadora); HL100 (Cortasetos)	4180 120 1800
14	12 10053	FS 240/260/360/410	4147 141 0300
15	12 10054	Pre-filtro 550	4116 141 0300
16	12 10055	560	4148 141 0300

Línea AZUL

FILTROS DE GASOLINA (compatible con Mitsubishi)



1

Nº	Referencia	Compatible con modelos	Ref. original
1	12 11015	TL 43/50/20	

Línea AZUL

FILTROS DE GASOLINA (compatible con Stihl)



2

Nº	Referencia	Compatible con modelos	Ref. original
2	12 11004	Filtro de gasolina D: 15 mm; Tubo: 5,7 mm	0000 350 3506

FILTROS DE GASOLINA (Universal)



3

Nº Referencia	Compatible con modelos	Ref. original
3 12 11005	Filtro de gasolina-D: 19 mm Tubo-D: 5mm	Universal

Línea AZUL

INTERRUPTORES DE PARE (compatible con Husqvarna/Jonsered)



1



Nº Referencia	Compatible con modelos	Ref. original
1 12 22017	365/372/240R/325R/232R /235R/240R/245R/343R/345R.	503 71 82 01 Jonsered BC2145/2186

Línea AZUL

INTERRUPTOR UNIVERSAL (Universal para desbrozadoras)



1

Nº Referencia	Compatible con modelos	Ref. original
1 12 22022		

Línea AZUL

JUEGO DE JUNTAS MOTOR (compatible con Kawasaki)



7

Nº Referencia	Compatible con modelos
7 12 33021	TD40

Línea AZUL

KITS CILINDRO+PISTÓN (compatible con Alpina)



1

Nº Referencia	Compatible con modelos	Ref. original
1 12 20027	VIP52, Star 55/Stiga SB52	8540970

Línea AZUL

KITS CILINDRO+PISTÓN (compatible con Husqvarna/Jonsered)

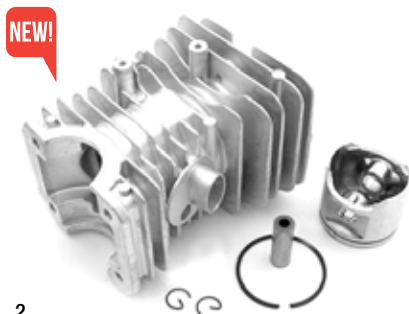

2

Nº Referencia	Compatible con modelos	Ref. original
2 12 20013	45/245R (Diámetro 42 mm)	503 44 08 02

Línea AZUL

KITS CILINDRO+PISTÓN (compatible con Kawasaki)



3

Nº Referencia	Compatible con modelos	Ref. original
3 12 20028	TH43 (Diámetro 41,5 mm)	11005-2122
4 12 20029	TH48 (Diámetro 44 mm)	11005-2123

Línea AZUL

KITS CILINDRO+PISTÓN (compatible con Oleo-Mac)

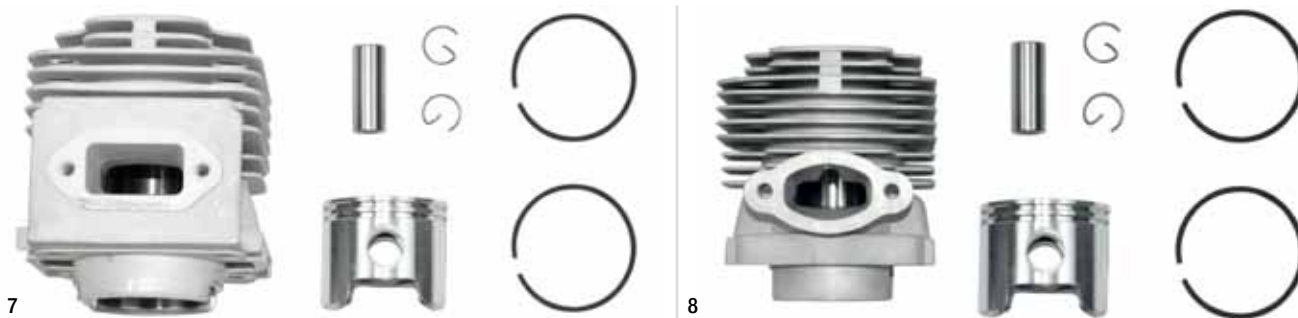

Nº	Referencia	Compatible con modelos	Ref. original
7	12 20032	750,Éfco 8500 (Diámetro 44 mm)	4191210
8	12 20033	753 (Diámetro 45 mm)	611 120 35H

Línea AZUL

KITS CILINDRO+PISTÓN (compatible con Stihl)



Nº	Referencia	Compatible con modelos	Ref. original
9	12 20034	FS450 (Diámetro 42mm)	4128 020 1211
10	12 20035	FS480 (Diámetro 44mm)	4128 020 1202
11	12 20036	FS550 (Diámetro 46 mm)	4116 020 1215
12	12 20037	FS120 / FS120R (Diámetro 35 mm)	4134 020 1213
13	12 20038	FS280 (Diámetro 40 mm)	4119 020 1207
14	12 20039	FS220 (Diámetro 38 mm)	4119 020 1204

Línea AZUL

KITS CILINDRO+PISTÓN (compatible con Mitsubishi)

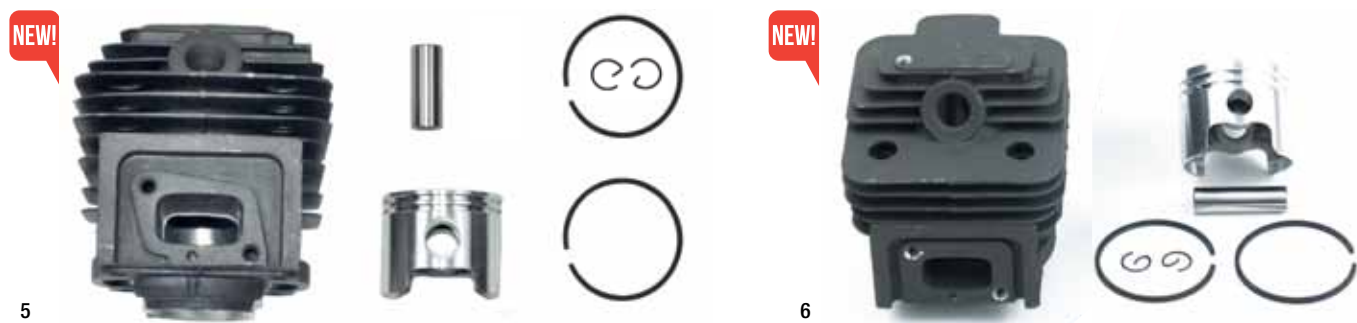

Nº	Referencia	Compatible con modelos	Ref. original
5	12 20030	TL43 (Diámetro 40 mm)	KC13010AA
6	12 20031	TL 52, Kubota 520 (Diámetro 44 mm)	

Linea AZUL

KITS DE REPARACIÓN DE CARBURADOR

(compatible con Mitsubishi)



Nº	Referencia	Compatible con modelos
1	12 31093	TL43

Linea AZUL

KITS DE REPARACIÓN DE CARBURADOR (compatible con Stihl)



Nº	Referencia	Compatible con modelos
2	12 31098	FS120 / 250 / 350 / 450
3	12 31097	FS106 / FS220 / FS280

Linea AZUL

MANDO ACELERADOR



Nº	Referencia	Compatible con modelos
1	63 AE31901TH48	Universal para tubos de 19 mm. Largo cable: 92cm
2	63 BC363M	Universal para tubos de 22 mm. Largo cable: 90cm
3	12 35014	Universal para tubos de 19mm. Largo cable: 83cm

Línea AZUL

MUELLES DE ARRANQUE (compatible con Husqvarna/Jonsered)



1

Nº	Referencia	Compatible con modelos	Ref. original
1	12 24002	36/ 40/ 41/ 45/ 51/ 55/ 136/ 141/ 240R/ 245R. ø:7mm	501 76 31 01

Línea AZUL

MUELLES DE ARRANQUE (compatible con Kawasaki)



2

Nº	Referencia	Compatible con modelos	Ref. original
2	12 24015	TD40/TD48/TH43/TH48	920812318

Línea AZUL

MUELLES DE ARRANQUE (compatible con Stihl)



3

Nº	Referencia	Compatible con modelos	Ref. original
3	12 24016	FS120/200/250/300/350/ 400/450/480. ø: 6mm	4134 190 0601

Línea AZUL

MUELLES DE EMBRAGUE (compatible con Husqvarna/Jonsered)



1

Nº	Referencia	Compatible con modelos	Ref. original
1	12 21001	40/45/51/55/254/257/240R 245R/240RX/245RX. Para embragues de un solo muelle	501 45 61 01

Línea
AZUL

PISTONES (compatible con Alpina)



1

Nº	Referencia	Compatible con modelos	Ref. original
1	12 44025	P500/510/VIP52/SP510 Star55/Stiga SB52 (45 mm)	8540960

Línea
AZUL

PISTONES (compatible con Husqvarna/Jonsered)



2

Nº	Referencia	Compatible con modelos	Ref. original
2	12 44001	45/245R-RX. Jonsered GR44/RS44/2045 (42 mm)	503 44 10 02

Línea
AZUL

PISTONES (compatible con Kawasaki)



3

Nº	Referencia	Compatible con modelos	Ref. original
3	12 44027	TH48 (44 mm)	13001-2141

Línea
AZUL

PISTONES (compatible con Mitsubishi)



Nº	Referencia	Compatible con modelos	Ref. original
4	12 44028	TL 52, Kubota (Diámetro 44 mm)	
	12 44029	TL 43, Kubota (Diámetro 40 mm)	

Línea AZUL

PISTONES (compatible con Stihl)



Nº	Referencia	Compatible con modelos	Ref. original
5	12 44030	FS220 (38 mm)	4119 030 2003
	12 44031	FS250 / FS350 (40 mm)	4134 030 2003
	12 44032 <small>NEW!</small>	025/FS450 (Diámetro 42 mm)	1123 030 2002 1128 030 2005
	12 44033 <small>NEW!</small>	Stihl FS480 / FR480 / SP481 (Diámetro 44 mm)	
	12 44034 <small>NEW!</small>	FS420 / FS550 (Diámetro 46 mm)	4116 030 2005

Línea AZUL

POLEAS DE ARRANQUE (compatible con Alpina)



Nº	Referencia	Compatible con modelos	Ref. original
1	12 25017	Vip34/40/42/52 Star 36/41/45/55/Stiga SB 36/40/44/52	45 62 440

Línea AZUL

POLEAS DE ARRANQUE (compatible con Husqvarna/Jonsered)



Nº	Referencia	Compatible con modelos	Ref. original
2	12 25018	232R/235R/322R/325R. Soplador 225B	503 77 53 01
3	12 25002	40/45/240R/245R	537 20 19 01 Ref.Antigua: 506 01 64 01

Línea AZUL

POLEAS DE ARRANQUE (compatible con Kawasaki)



Nº	Referencia	Compatible con modelos	Ref. original
4	12 25020	TD40/TD48 -TH43/TH48	591012067

Línea AZUL

POLEAS DE ARRANQUE (compatible con Mitsubishi)



Nº	Referencia	Compatible con modelos	Ref. original
5	12 25021	TL43, Kubota K430	

Línea AZUL

POLEAS DE ARRANQUE (compatible con Oleo-Mac)



6

Nº	Referencia	Compatible con modelos	Ref. original
6	12 25022	740	72700085B

Linea AZUL

POLEAS DE ARRANQUE (compatible con Stihl)



7

NEW!



8

Nº	Referencia	Compatible con modelos	Ref. original
7	12 25023	FS38/55/100/120/200/300/350/400/450/HL100/HL450	4128 195 0400
8	12 25024	FS160 / 220 / 280	

Linea AZUL

SEGMENTOS (compatible con Kawasaki)



1

Nº	Referencia	Compatible con modelos	Ref. original
1	12 45063	TD33 (37 mm)	13008-6045
	12 45064	TH43 (41,5 mm)	13008-6052
	12 45065	TH48 / TD48 (44 mm)	13008-6044
	12 45066	TD40 (40 mm)	13008-6049

Linea AZUL

TAPONES DE GASOLINA (compatible con Kawasaki)



1

Nº Referencia	Compatible con modelos	Ref. original
1 12 26010	TD 33/40/48-TH 23/26/34/43/48	510482078

Línea AZUL

TAPONES DE GASOLINA (compatible con Mitsubishi)



2

Nº Referencia	Compatible con modelos	Ref. original
2 12 26011	TL 33/43/52	

Línea AZUL

TORNILLO EMBRAGUE (compatible con Mitsubishi)



1

Nº Referencia	Compatible con modelos
1 12 17022	TL 43 / 52

Línea AZUL

TRINQUETES (compatible con Husqvarna/Jonsered)



1



2

Nº Referencia	Compatible con modelos	Ref. original
1 12 58001	61/262/268/281/288/395/265RX/356BTX... Para distintos modelos de motosierras, desbrozadores y sopladores	501 67 32 01
2 12 58008	Kit trinquete + muelle 61/262/268/281/288/395/265RX/356BTX... Para distintos modelos de motosierras, desbrozadores y sopladores	501 67 32 01/501 67 35 01

TUBO + TRANSMISIÓN

NEW!

1



Nº	Referencia	Compatible con modelos
1	63 BC361T	Tubo de 150x26 mm + transmisión 9 estrías
	63 BC461	Tubo de 150x28 mm + transmisión 9 estrías

Línea
AZUL



KURIA®

MOTOGARDEN, S.A.

C/ Eduardo Pondal, s/n
Poligono de Sigüeiro, Parcela 58
15688 Sigüeiro-Oroso (A Coruña)

Tel. +34 981 69 63 08
Fax. +34 981 69 08 78

motogarden@motogarden.com
www.motogarden.com

RECAMBIOS Y MAQUINARIA VARIA

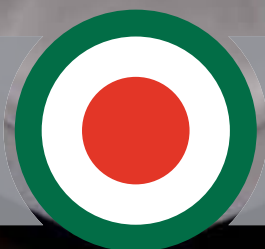

KURITA®

BAYGAR

AMORTIGUADORES (compatible con Stihl)



1



2



3

Nº Referencia	Compatible con modelos	Ref. original
1 12 34023	024/026/028/034/036/038/044/046/064/066/MS461/MS650/TS400/TS460. (Tapón amortiguador)	1125 791 7306
2 12 34025	038/084/088/TS400 (Tapón amortiguador)	1119 791 7306
3 12 34027	024/026/038/MS260/MS880/TS400	1121 790 9912

Linea AZUL

BRIDAS DE ADMISIÓN / CODOS DE ADMISIÓN

(compatible con Stihl)



1

Nº Referencia	Compatible con modelos	Ref. original
1 12 52027	TS400/TS700/TS800	4223 141 2200

Linea AZUL

CABLES ACELERADOR (compatible con Stihl)

NEW!



1

Nº Referencia	Compatible con modelos	Ref. original
1 12 35029	Sopladores Stihl	4229 180 1101

Linea AZUL

CARBURADORES (compatible con Stihl)



1

Nº Referencia	Compatible con modelos	Ref. original
1 12 30033	Tillotson compatible con TS400 (Cortadora de disco)	HS-279D

CIGÜEÑALES (compatible con Stihl)



1

Nº Referencia	Compatible con modelos	Ref. original
1 12 37011	TS400 (Cortadora de disco)	4223 030 0400

Línea AZUL

EMBRAGUES (compatible con Stihl)



1

Nº Referencia	Compatible con modelos	Ref. original
1 12 17023	TS400 (Cortadora de disco)	1125 160 2005

Línea AZUL

ESCAPES (compatible con Stihl)



1



2

Línea AZUL

Nº Referencia	Compatible con modelos	Ref. original
1 12 49017	SR420 (Atomizador)	4203 140 0602
2 12 49018	TS400 (Cortadora de disco)	4223 140 0601

FILTROS DE AIRE (compatible con Echo)



1

Nº Referencia	Compatible con modelos	Ref. original
1 12 10056	PB4000/ PB6000 (Soplador) (Medidas en mm: 263x73x33)	130305 08360 130305 081366

FILTROS DE AIRE (compatible con Echo/Husqvarna)



2

Nº Referencia	Compatible con modelos	Ref. original
2 12 10057	ZENOAH EBZ8001 / Husqvarna 170BT / 370BTS / 570BTS / 580BTS	512 65 20 01

Línea AZUL

FILTROS DE AIRE (compatible con Partner)



3



4



5

Nº Referencia	Compatible con modelos	Ref. original
3 12 10058	Pre-filtro K-750 (Cortadora de disco)	506 36 71 01
4 12 10059	K-750 (Cortadora de disco) (Medidas en mm: 123x113x35)	506 36 72 03
5 12 10060	Pre-filtro K-1250 Active/ Husqvarna K1250 (Cortadora de disco)	506 26 87 01

Línea AZUL

Las referencias o alusiones a otras marcas hechas en el catálogo sólo son indicativas y sirven para la comprobación de nuestros productos. Suministramos SÓLO PIEZAS NO ORIGINALES.

FILTROS DE AIRE (compatible con Stihl)



Nº	Referencia	Compatible con modelos	Ref. original
6	12 10052	FS 87/100/130/310 (Desbrozadora); HL100 (Cortasetos)	4180 120 1800
7	12 10062	SR320/400 (Pulverizador) BR320/400 (Soplador)	4203 141 0300
8	12 10063	BR420 (Soplador) (Medidas en mm: 130x85x35)	4203 141 0301
9	12 10064	BR500/BR550/BR600 (Soplador) (Medidas en mm: 130x80x30)	4282 141 0300
10	12 10065	TS400 espuma (Cortadora de disco)	4223 141 0600
11	12 10066	TS400 cartón (Cortadora de disco) (Medidas en mm: 130x85x45)	4223 141 0300
12	12 10067	TS400 (Cortadora de disco)	4223 140 1800

Línea AZUL

JUEGOS DE JUNTAS MOTOR (compatible con Partner)



Nº	Referencia	Compatible con modelos	Ref. original
1	12 33013	K650 Active (Cortadora de disco)	506 34 88 01

JUEGOS DE JUNTAS MOTOR (compatible con Stihl)

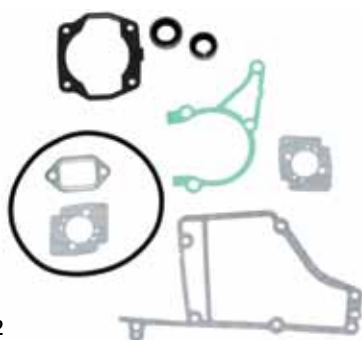

2

Nº Referencia	Compatible con modelos	Ref. original
2 12 33014	TS400 (Cortadora de disco)	4223 007 1050

Línea AZUL

KITS CILINDRO + PISTÓN (compatible con Stihl)



1



2

Nº Referencia	Compatible con modelos	Ref. original
1 12 20040	TS400. Diámetro 49 mm. (Cortadora de disco)	4223 020 1200
2 12 20041	TS700/TS800. Diámetro 56 mm. (Cortadora de disco)	4224 020 1202

Línea AZUL

MUELLES DE ARRANQUE (compatible con Husqvarna/Partner)



1

Nº Referencia	Compatible con modelos	Ref. original
1 12 24017	K650/K750/K760/K950/ K960/K970 (Cortadora de disco) ø: 5mm	506 25 89 01

Línea AZUL

MUELLES DE ARRANQUE (compatible con Stihl)



2

Nº Referencia	Compatible con modelos	Ref. original
2 12 24018	TS400 (Cortadora de disco) ø: 6mm	4223 190 0600

PISTONES (compatible con Stihl)



1

Línea AZUL

Nº Referencia	Compatible con modelos	Ref. original
1 12 44035	TS400 (Cortadora de disco)	4223 030 2000

POLEAS DE ARRANQUE (compatible con Husqvarna/Jonsered)



1

Línea AZUL

Nº Referencia	Compatible con modelos	Ref. original
1 12 25018	232R/235R/322R/325R. Soplador 225B	503 77 53 01

POLEAS DE ARRANQUE (compatible con Partner/Husqvarna)



2

Línea AZUL

Nº Referencia	Compatible con modelos	Ref. original
2 12 25026	K650/K750/K760/K950/K960/K970	506 25 81 02

POLEAS DE ARRANQUE (compatible con Stihl)



3

Línea AZUL

Nº Referencia	Compatible con modelos	Ref. original
3 12 25023	FS38/55/100/120/200/300/350/400/450/HL100/HL450	4128 195 0400

RETENES CIGÜEÑAL (compatible con Husqvarna/Jonsered)



1

Nº	Referencia	Compatible con modelos	Ref. original
1	12 43064	Husqvarna 61/268/K750 (15x26x6)	503 26 02 04



RETENES CIGÜEÑAL (compatible con Stihl)



2

Nº	Referencia	Compatible con modelos	Ref. original
2	12 43076	066/MS261/MS361/TS410 (15x22x4)	9640 003 1560
	12 43081	TS400/TS700 (17x28x7) (Cort disco)	9640 003 1745
	12 43082	TS400 (15x24x7) (Cortadora de disco)	9640 003 1570
	12 43083	TS 410 (15X26X7) (Cortadora de disco)	9630 951 1696



SEGMENTOS (compatible con Stihl)

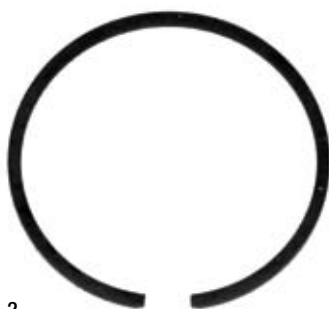

2

Nº	Referencia	Compatible con modelos	Ref. original
1	12 45030	Stihl TS400 (49X1.5) (Cort. disco) (2PCS)	1127 034 3006
	12 45031	Stihl TS700 (56X1.5) (Cort. disco) (2PCS)	1115 034 3013



TRINQUETES (compatible con Husqvarna/Jonsered)



1



2

Nº	Referencia	Compatible con modelos	Ref. original
1	12 58001	61/262/268/281/288/395/265RX/356BTX... Para distintos modelos de motosierras, desbrozadores y sopladores	501 67 32 01
2	12 58008	Kit trinquete + muelle 61/262/268/281/288/395/265RX/356BTX... Para distintos modelos de motosierras, desbrozadores y sopladores	501 67 32 01 / 501 67 35 01

CORREAS CORTACÉSPED



CORREAS (Dentada)



Referencia	Compatible con modelos	Ref. original
12 61001	Corte 102 Cm. SOLO-CASTELGARDEN-VIKING-HONDA...	350656000
12 61002	Corte 122 Cm. SOLO-CASTELGARDEN-VIKING-HONDA...	350656010

Línea AZUL

CORREAS (compatible con Castelgarden)



Referencia	Compatible con modelos	Ref. original
12 61003	TC102/TC122 - Tracción	35062011
12 61004	NEW! TC 92 / Stiga Estate 92- Cuchilla. Medidas 12,7x2221,50	350657000
12 61005	TC 92 / Stiga Estate 2084, 3084, 5092, Alpina BT84 (Desde 2007) Cuchilla. Medidas 12,7 X 2235,2	350657010
12 61006	TC122, Stiga Estate 122 - Cuchilla	35062814/0
12 61007	XAP55MBS/NP53 / Honda IZY 53, HRG 536 C3	35064195/0 / 664 064 195 22431-Vg4-B50
12 61008	NG504TR - Tracción	350639020
12 61009	TC F92/Solo 560 - Tracción	350620001
12 61010	TC15,5/98H-J	35061980/0
12 61011	TC102H/TC122H / Stiga Estate 102 / 122 Cm - Tracción (Hydro)	35062001/0
12 61012	T434TR / Honda HRG 415CSD - Tracción	35063710 / Cg35063710hd
12 61013	TC102, Stiga Estate 102 Cm, Dino 12,5KM/102Cm, Honda HF2417 - (17 X 1397 Li) - Cuchilla, Karsit - Tracción Corte	012434 / 350628110 / 000 433 103/ 350628130
12 61014	TC102 (Antiguo), Stiga Estate 102 (Antiguo) Solo 570 - Tracción	35061501

Línea AZUL

Las referencias o alusiones a otras marcas hechas en el catálogo sólo son indicativas y sirven para la comprobación de nuestros productos. Suministramos SÓLO PIEZAS NO ORIGINALES.

CORREAS (compatible con Husqvarna/Jonsered)



Referencia	Compatible con modelos	Ref. original
12 61015	CT135/CTH135/CTH150,Partner P1292RB,McCulloch M13592RB Cuchilla. Corte 92 Cm	532 40 20 08/ 532 18 02 17/ 532 16 55 55
12 61016	AYP38" Tracción. Medidas 12,7 X 229,9. Tracción	532 19 32 14/ 532 12 59 07
12 61017	CTH 150 - Tracción	583 03 67 01 Ref. Antigua: 532 17 01 40
12 61018	CTH 150, 180 / Partner P18H107RB / McCulloch M185107HRB Cuchilla. Corte 107 Cm	532 40 20 09 Ref-Antigua: 532 16 91 78
12 61019	LT151 / Murray Cuchilla 30"/76Cm, 36"/96Cm, 40"/102Cm Tráctor Cortacésped Por Tracción. 37X87	532 19 43 46

Línea
AZUL

CORREAS (compatible con John Deere)



Referencia	Compatible con modelos	Ref. original
12 61020	X-125/ X-145 - Cuchilla	GX20072
12 61021	X-125/ X-145 - Tracción	GX20006

Línea
AZUL

CORREAS (compatible con MTD)



Referencia	Compatible con modelos	Ref. original
12 61022	Tractor Cortacésped 102Cm - Cuchilla	754 0443A
12 61023	B155,H165,T102 - Tracción	754 0370
12 61024	Toro LX460. Tractor Cortacésped - Cuchilla . Medidas 12,7 X2292	754 04122 / 112 5834
12 61025	LG175 ,Bolens BL 135/96, 175/107T - Tracción	754 0241
12 61026	GES53/53SPO, 53SP/T Bolens BL5053 SP - Tracción	754 0271
12 61027	Smart RG125/ RG145, Optima LF130 - Tracción	754 04249/954 04249
12 61028	JE130/RH125/Spider92/SLX92 - Tracción	754 0492
12 61029	Platinum/JN180H/Gutbrod GLX 92 RH, GLX 105 RH, GLX 122 RH . Tracción	754 0125
12 61030	Series 450/500-92Cm - Tracción	754 0632
12 61031	B10, B115, J130, B155 Spider 76, Spider 91 Gudbrod SLX 96. Tracción Motor	754 0280
12 61032	Modelos 760-799 (Automáticos), LA135, BL175/107T, JLX76RA - Tracción Blue Kevlar	754 04170
12 61033	Modelos 760-799 (Automáticos) , JLX76RA, LE155, BL175/107T, SC220/105, RH125/92 - Tracción - Blue Kevlar	754 04171
12 61034	B135 / B155 Tracción - Nuevo	754 04002
12 61035	RS125/96,RS135/107, LG175, Gutbrod SLX107H, Bolens BL175/107T- Cuchilla	754 04060

Línea AZUL

CORREAS (compatible con Murray)



Referencia	Compatible con modelos	Ref. original
12 61036	37X75 Tráctor Cortacésped 107 Cm - Cuchilla	37X25
12 61037	MX 550, Mxh 675	754 0369 / 754 04184 / 700123
12 61038	Cuchilla 40" / 102Cm - Cuchilla	37X62
12 61039	Tractores Cortacésped 12,5 KM - Cuchilla 102 Cm - HEX	710232

Línea AZUL

CUCHILLAS CORTACÉSPED



Cuchillas
Cortacésped



KURIBANG®

BAYGAR

CUCHILLAS (compatible con CastelGarden)

* Son medidas mínimas

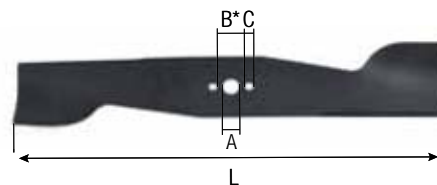

1



2



3



4



5



6



7



8



9



10

Nº	Referencia	Compatible con modelos	Ref. original
1	12 66001	Bingo (A=18 ; B=36,5 ; C=8; L=37)	81004117/0
2	12 66002	TC 102 C -derecha (A=18 ; B=56,5 ; C=8,5; L=51,9)	82004340/0
3	12 66003	TC 102 C - izquierda (A=18 ; B=56,5 ; C=8,5; L=51,9)	82004341/0 - 82004341
4	12 66004	TC 122 C / Honda - izquierda (A=18 ; B=56,5 ; C=8,5; L=61,5)	82004343/0
5	12 66005	TC 122 C - derecha (A=18 ; B=56,5 ; C=8,5; L=61,5)	82004342/0
6	12 66006	CastelGarden/OleoMac/Efco TC 92, Junior - izquierda (A=18 ; B=56 ; C=8,5; L=46)	82004345/0
7	12 66007	TC 92 - derecha (A=18 ; B=56,5 ; C=8,5; L=46,2)	82004344/0
8	12 66008	TD 534, R 534, R 534 TR , XS 55, Raser 534, T 534 (A=18 ; B=56,5 ; C=8,5; L=51)	81004398/0
9	12 66009	T430/T480/R484 (A=18 ; B=56,5 ; C=8,5; L=46)	81004346
10	12 66010	R 430/434, TD 430/434, Stiga Collector 43 - mulching (A=18 ; B=56,5 ; C=8,5; L=41,2)	81004341



CUCHILLAS CORTACÉSPED

CUCHILLAS (compatible con CastelGarden)

* Son medidas mínimas

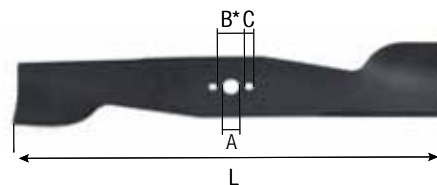

11



12



13



14



15



16



17



18

Nº	Referencia	Compatible con modelos	Ref. original
11	12 66011	F72 /Stiga Estate Senator (A=18 ; B=56,5 ; C=8,5; L=71)	84109500/0 - 84109500
12	12 66012	R484 BIO (A=18 ; B=56,5 ; C=8,5; L=46)	81004346/3
13	12 66013	Bio Alpina A102, Castelgarden PT170, TwinCut TC102C, Stiga Estate Royal - izquierda (A=18 ; B=56,5 ; C=8,5; L=52)	82004347/0
14	12 66014	Bio Alpina A102, Castelgarden PT170, TwinCut TC102C, Stiga Estate Royal - derecha (A=18 ; B=56,5 ; C=8,5; L=52)	82004348/0
15	12 66015	Bio Alpina A92/C92, Castelgarden PG170, Stiga Estate Senator - izquierda (A=18 ; B=56,5 ; C=8,5; L=46)	82004353/0
16	12 66016	Bio Alpina A92/C92, Castelgarden PG170, Stiga Estate Senator - derecha (A=18 ; B=56,5 ; C=8,5; L=46)	82004354/0
17	12 66017	BIO Twin Cut 122 - derecha (A=18 ; B=56,5 ; C=8,5; L=62)	82004349/0
18	12 66018	BIO Twin Cut 122 - izquierda (A=18 ; B=57,5 ; C=8; L=62)	82004350/0

Línea
AZUL

CUCHILLAS (compatible con Honda)

* Son medidas mínimas

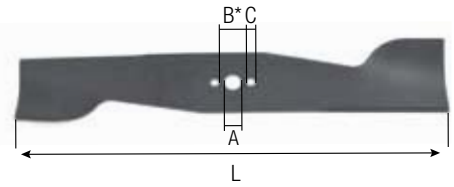

Nº	Referencia	Compatible con modelos	Ref. original
1	12 66019	HRX537 - inferior (A=21 ; B=78 ; C=10,5;L=53)	72511-VH7-000
2	12 66020	HRB423K1/SG/PG (A=28 ; B=44/83,5 ; C=6/10,5; L=42)	72511-VA9-H500
3	12 66021	HRG 536C, HRH 536, IZY 53 (A=23 ; B=78 ; C=14;L=52,5)	72511-VE1-650
4	12 66022	R430, R434 Honda HRG 415CSD, HRG 415CSP (A=18 ; B=56,5 ; C=8,5; L=40)	81004396/0

Linea AZUL

CUCHILLAS

(compatible con Husqvarna/Jonsered/McCulloch/Partner/Poulan)

* Son medidas mínimas

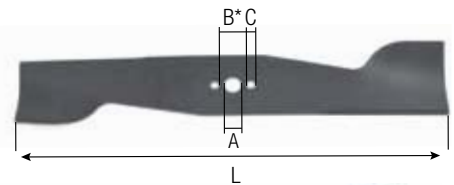

Nº	Referencia	Compatible con modelos	Ref. original
1	12 66023	CTH 171/184/194/224, McCulloch M155-107TC. Jonsered LT 2320-LT 2318 - derecha (A=5 ESTRÍAS; L=54). A partir de 2012 HUSQ-TC142/TC242/TC342/McCulloch M155/107TC/M185/107TC/M200/107TC	581 51 80 01
2	12 66024	CTH 171/184/194/224, McCulloch M155-107TC. Jonsered LT 2320-LT 2518- izquierda (A=5 ESTRÍAS; L=54). A partir de 2012 HUSQ-TC142/TC242/TC342/McCulloch M155/107TC/M185/107TC/M200/107TC	581 51 79 01
3	12 66025	LC48/ LC148/ M148 (A=17 ; B=28 ; C=12; L=48)	505 52 41 01
4	12 66026	LC53 - nueva (A=17 ; B=28 ; C=12,5; L=53)	510 43 64 01
5	12 66027	LB48/LC48 (A=17 ; B=28 ; C=13,5; L=47,5)	510 43 66-01
6	12 66028	LT100, LT125 / Rally 12,5KM - tractores cortacésped 92cm (A=5 ESTRÍAS; L=46) Jonsered LT14/LT2115/LR12/LT2114/LRH13	532 13 84 96. Ref.Antigua: 532 12 78 41

Las referencias o alusiones a otras marcas hechas en el catálogo sólo son indicativas y sirven para la comprobación de nuestros productos. Suministramos SÓLO PIEZAS NO ORIGINALES.

CUCHILLAS CORTACÉSPED

CUCHILLAS

(compatible con Husqvarna/Jonsered/McCulloch/Partner/Poulan)

* Son medidas mínimas

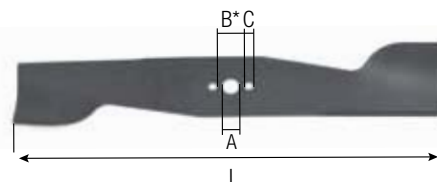

7



8



9



10



11



12



13



14



15



16

Nº	Referencia	Compatible con modelos	Ref. original
7	12 66029	Royal R52, R152SV. Jonsered LM2152/ LM2153 (A=16 ; B=45 ; C=10; L=53,2)	532 19 93 77 / 532 40 67 12
8	12 66030	CT151/131 - izquierda - 5* (A=5 ESTRÍAS; L= 49,8). Corte 97 cm Partner P12597/P13597 - Husqvarna CTH174/CTH173/CT154/TC238/TC38 Jonsered LT2217/LT2317/LT2316/LT2114/McCulloch M12597/M175H38/M144597/M11597	532 42 79 84
9	12 66031	CT151/131 - derecha - 6 (A=6 ESTRÍAS; B=70 ; C=1; L=49,8). Corte 97 cm Partner P12597/P13597 - Husqvarna CTH174/CTH173/CT154/TC238/TC38 Jonsered LT2217/LT2317/LT2316/LT2114/McCulloch M12597/M175H38/M144597/M11597	532 42 79 85
10	12 66032	CT126/CTH126, Partner P11577RB (A=5 ESTRÍAS ; B=29,5 ; C=9,5; L=76) Husqvarna TC130/Jonsered LT2213/McCulloch M11577	532 41 92 74
11	12 66033	CT130, CTH150 - izquierda (A=5 ESTRÍAS ; B=10; L=46,5). Corte 92 cm	532 16 55 60
12	12 66034	CT130, CTH150 - derecha (A=6 ESTRÍAS; L= 46,5). Corte 92 cm	532 16 55 61
13	12 66035	Husqvarna Royal 43, 43S, 43SE / Partner P43, P431 /Flymo (A=16 ; B=26,5 ; C=8,5; L=42)	511 88 04 00
14	12 66036	RiderPRO 14, 15, 18, 20 Rider 16, 970, 13R, 16H (A=10 ; B=53 ; C=8; L=34,9)	531 00 50 10
15	12 66037	CTH151, 171 - 92cm - derecha superior (A=6 ESTRÍAS ; B=73 ; C=13; L=46,4) Jonsered/McCulloch/Lazer/Partner con doble cuchilla 92cm de corte.	532 18 63 86
16	12 66038	CTH151, 171 - 92cm - derecha inferior (A=10; B=70; L=46,4) Jonsered/McCulloch/Lazer/Partner con doble cuchilla 92cm de corte.	532 19 63 88

CUCHILLAS

(compatible con Husqvarna/Jonsered/McCulloch/Partner/Poulan)

* Son medidas mínimas

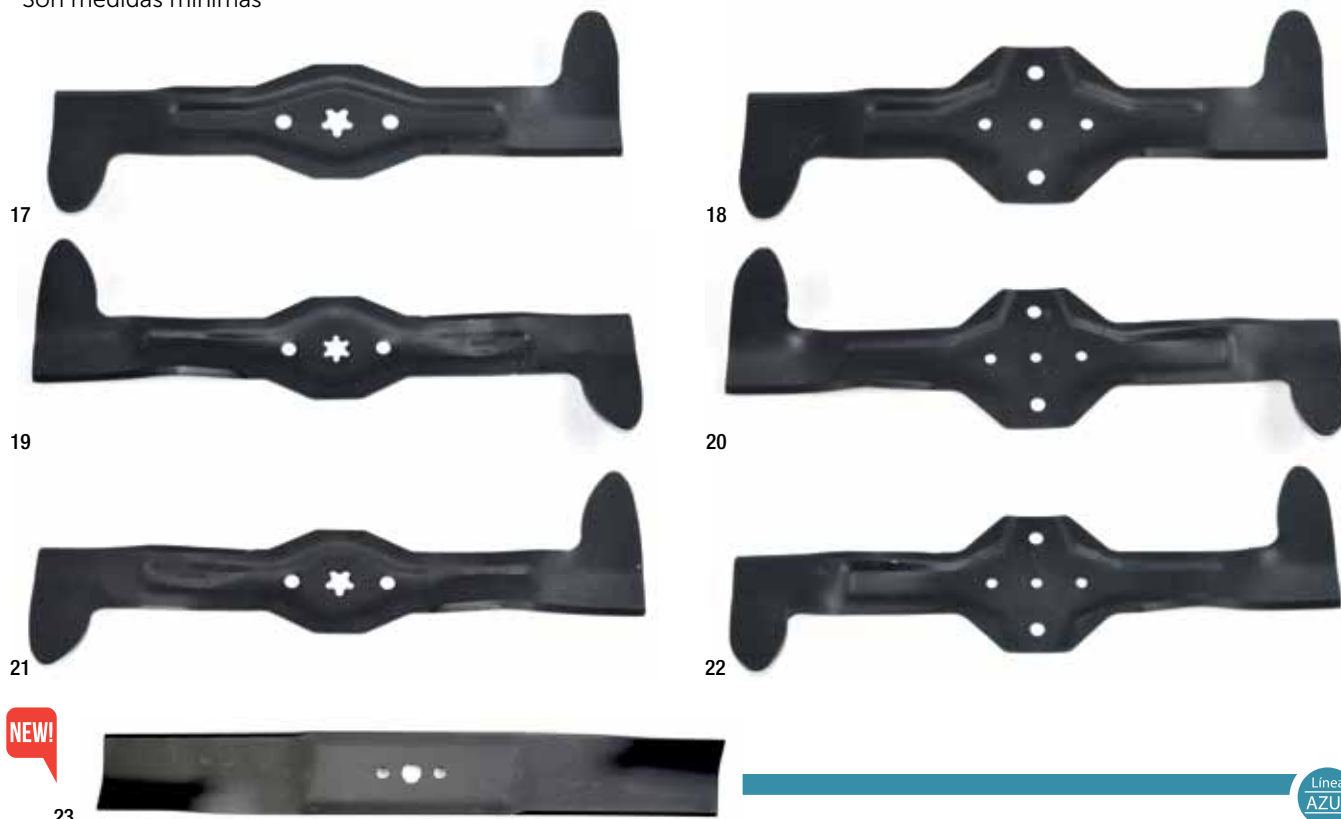
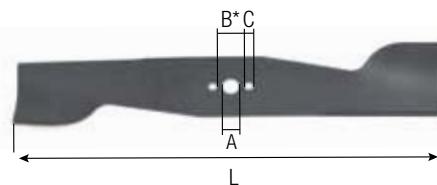

Nº	Referencia	Compatible con modelos	Ref. original
17	12 66039	CTH151, 171-92cm-izquierda superior (A=5 ESTRÍAS; B=73,5; C=13; L=46,4) Jonsered/McCulloch/Lazer/Partner con doble cuchilla 92cm de corte	532 18 63 85
18	12 66040	CTH151, 171 - 92cm - izquierda inferior (A=10 ; B=70 ; C=10; L=46,4) Jonsered/McCulloch/Lazer/Partner con doble cuchilla 92cm de corte	532 18 63 87
19	12 66041	CTH180/200 (A=6 ESTRÍAS ; B=73 ; C=13; L=54,3) Derecha superior. Jonsered/ Partner /McCulloch	532 18 05 84
20	12 66042	CTH180/200 (A=10 ; B=70 ; C=10; L=54,3) Derecha inferior Jonsered/ Partner /McCulloch	532 18 04 25
21	12 66043	CTH180/200 (A=5 ESTRÍAS ; B=72 ; C=13; L=54,3) Izquierda superior Jonsered/ Partner /McCulloch	532 18 05 83
22	12 66044	CTH180/200 (A=10 ; B=70 ; C=10; L=54,3) izquierda inferior Jonsered/ Partner /McCulloch	532 18 04 24
23	12 66138	Husqvarna R52SE/P5553/753. Jonsered/ Partner /McCulloch	

CUCHILLAS (compatible con Murray)

* Son medidas mínimas



Nº	Referencia	Compatible con modelos	Ref. original
1	12 66057	Cuchilla 102 cm- derecha-tractores cortacésped (A=22,5 ROMBO; L=52)	94208
2	12 66058	Cuchilla 102 cm- izquierda-tractores cortacésped (A=22,5 ROMBO; L=52)	94209

CUCHILLAS CORTACÉSPED

CUCHILLAS (compatible con MTD)

* Son medidas mínimas

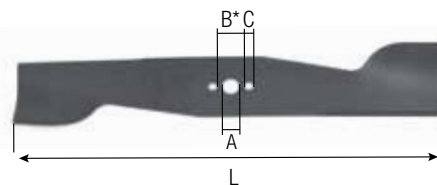

1



2



3



4



5



6



7



8



9



10



11



12

Nº	Referencia	Compatible con modelos	Ref. original
1	12 66045	46EL (A=32; L=45,5)	742 04028 / 742 04026
2	12 66046	Smart 42, Optima 42 (A=17,5 (4 ESTRÍAS) ; B=56 ; C=8; L=41,9)	742 04396
3	12 66047	Advance 53 SPK V HW, Smart 53, Optima 53, Wolf Expert 53 (A=17 (4 ESTRÍAS) ; B=56 ; C=8; L=53)	742 05024
4	12 66048	HWD 4046, Select 4600, HW46, BMR46, 4046T3, Wolf Ambition 46B, HW46A (A=17 (4 ESTRÍAS) ; B=55,5 ; C=9; L=46)	742 04316
5	12 66049	46 P, 46 SP, 46 SPT (A=17,5 (4 ESTRÍAS) ; B=55 ; C=8; L=45,5)	742 0818
6	12 66050	48SP, 48PT, 48SPMT Gudbrod HB48L (A=17,5 ; B=55 ; C=8; L=47,5)	742 0822
7	12 66051	RH125 - izquierda (A=6 ESTRÍAS; L= 46)	742 04021 / 742 0672
8	12 66052	RH125 - derecha (A=6 ESTRÍAS; L= 46)	742 04020 / 742 0673
9	12 66053	JN150/200 -izquierda (A=6 ESTRÍAS; L=53,8)	742 04081 / 742 0671
10	12 66054	JN150/200 - derecha (A=6 ESTRÍAS; L= 53,8)	742 04080 / 742 0671
11	12 66055	YardMan 40 TN145 - derecha (A=10,5 ; B=55 ; C=9,5; L= 51,5)	742 0607
12	12 66056	YardMan 40TN145 - izquierda (A=10,5 ; B=55 ; C=9,5; L=51,5)	742 0608

CUCHILLAS (compatible con Snapper)

* Son medidas mínimas

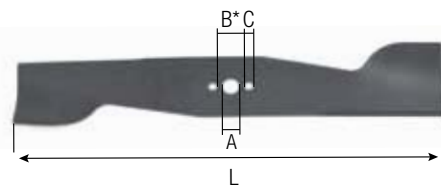

1



2

Nº	Referencia	Compatible con modelos	Ref. original
1	12 66059	ELT 1838RDF, Cuchilla 96cm - izquierda (A=20; L=49,5)	885418
2	12 66060	ELT 1838RDF, Cuchilla 96cm - derecha (A=20; L=49,5)	885419

Linea AZUL

CUCHILLAS (compatible con Stiga)

* Son medidas mínimas

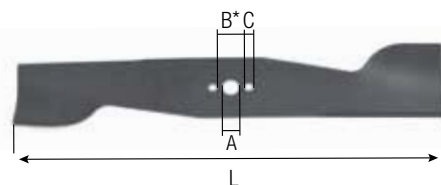

1



2



3



4

Nº	Referencia	Compatible con modelos	Ref. original
1	12 66061	Euro 45, Swing 45, Colector 45, Combi (A=9,8 ; B=41 ; C=10,5; L= 45)	010.00.24.0 / 81004121/0
2	12 66062	Swing 40, Euro 40, Colector 40 - gasolina (A=10 ; B=41,5 ; C=10,8; L=39,8)	81004122/0
3	12 66063	Park 110 Combi (A=TRIÁNGULO DIÁMETRO 32; L= 40,6)	1134-9124-01
4	12 66064	Park 125 Combi (A=TRIÁNGULO DIÁMETRO 32; L=46,5)	1134-9125-01

Linea AZUL

CUCHILLAS (compatible con Viking)

* Son medidas mínimas

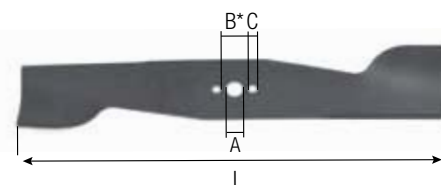

1



2

Nº	Referencia	Compatible con modelos	Ref. original
1	12 66065	MB3R (A=32 ; B=56,5 ; C=8,5;L=47)	6105 702 0121
2	12 66066	ME450/MB455 (A=18 ; B=57/84 ; C=8,5/10; L=43)	6103 702 0102

CUCHILLAS CORTACÉSPED

CUCHILLAS (Universal)



1

Nº	Referencia	Compatible con modelos	Ref. original
1	12 66067	Universal 38 cm	
2	12 66068	Universal 40 cm	
3	12 66069	Universal 43 cm	
4	12 66070	Universal 46 cm	
5	12 66071	Universal 48 cm	
6	12 66072	Universal 51 cm	
7	12 66073	Universal 53 cm	
8	12 66074	Universal 56 cm	

Línea
AZUL

SOPORTE DE CUCHILLAS (compatible con Husqvarna)

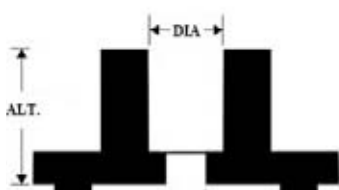

1



2



3



4



5



6



7

Nº	Referencia	Compatible con modelos	Ref. original
1	12 66086	LB48/LC48, Erma 948CV (Alto=85; Diámetro= 22,2)	581 84 31 01 Ref. Antigua: 531 20 78 98
2	12 66087	Jet55S/ Partner 553CME (Alto=71; Diámetro=25,4)	532 18 19 79
3	12 66088	R146S, R147S/SH/SV, McCulloch (Alto=54; Diámetro=22,2)	10 1202 00
4	12 66089	LC146/ R147, Marazzini (Alto=53; Diámetro= 22,2)	581 84 30 01 /531 20 61 69/10155040
5	12 66090	AYP/Nac Molgo (Alto= 30; Diámetro= 22,2; Altura interior= 1)	532 85 09 77
6	12 66091	AYP/Nac Molgo R52 (Alto=30; Diámetro= 22,2; Altura interior= 7/8)	532 85 15 14
7	12 66092	Royal, Master (Alto= 35; Diámetro= 22,2)	531 00 50 28

SOPORTE DE CUCHILLAS (compatible con CastelGarden)



Nº	Referencia	Compatible con modelos	Ref. original
1	12 66075	NG 414, NG 504, NG 464, CA 434, XS 45B - motores Honda (Alto= 50,5; Diámetro= 25,4)	22463020/0
2	12 66076	S474L (Alto= 36; Diámetro= 22,2)	22463015
3	12 66077	NG 464TR, NG 504TR, T 484TR, TDL 534, Spark 484 - motores Honda (Alto= 68; Diámetro= 25,4)	22465608/1
4	12 66078	TC92/102/122 (Alto= 36; Diámetro= 20)	25463200
5	12 66079	NG410 (Alto=40; Diámetro= 26,4) PVC	22463186/1
6	12 66080	NG410/464TR (Alto= 50,5)	22463020
7	12 66081	NG414, 464, R484, NG504 (Alto= 50,5; Diámetro= 22,4)	22463012
8	12 66082	NG 464 TR, 504 TR (Alto= 68; Diámetro= 22,2)	22465607/0
9	12 66083	T434 (Alto= 89; Diámetro= 22,2)	22465605
10	12 66084	T434 (Alto=36; Diámetro= 22,2)	22465604
11	12 66085	504TR/TRE / Stiga Multiclip 46 (Alto= 35; Diámetro=22,2)	22463016/0 / 1111 9066 01

Línea AZUL

SOPORTE DE CUCHILLAS (compatible con MTD)



Nº	Referencia	Compatible con modelos	Ref. original
1	12 66093	Con motores Honda- cuello alto (Alto= 55; Diámetro= 25,4)	748 04082
2	12 66094	53SPO/ 53-60SPKM/ 46SPBE/ GL46SPO (Alto=76; Diámetro= 22,2)	687 02555
3	12 66095	Con motores Honda- cuello bajo (Alto= 30; Diámetro= 25,4)	748 04096
4	12 66096	YM6521/GES53 (Alto= 55; Diámetro= 22,2)	748 0377C
5	12 66097	51/46P/508N (Alto= 30; Diámetro= 22,2)	748 0376C
6	12 66098	Cuchilla 30 + 32 + 40 B115, J115, Spider 91 (Alto=22,5; Diámetro= 25,4)	748 0300
7	12 66099	Agujero circular (Alto=30; Diámetro= 22,2)	748 0323 / 753 0484
8	12 66100	Compatible con MTD & Bolens (Alto= 2,5)	736 0524

Línea AZUL

SOPORTE DE CUCHILLAS (compatible con Harry)

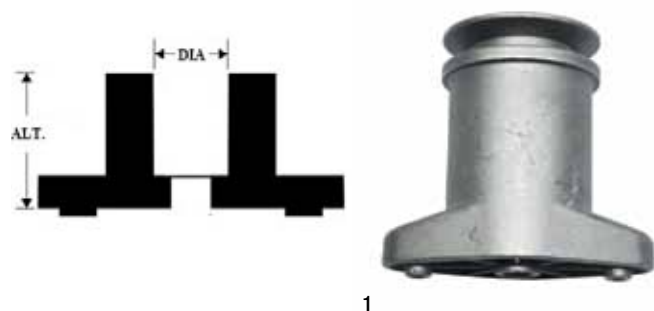

Nº	Referencia	Compatible con modelos	Ref. original
1	12 66101	S48/ S49/ C49, Active (autopropulsado) (Alto=86; Diámetro=22,2)	50608 / 402308100

SOPORTE DE CUCHILLAS (compatible con Murray)



Nº	Referencia	Compatible con modelos	Ref. original
1	12 66102	MP 500, MPH 550 (Alto= 52;Diámetro= 22,2)	700000
2	12 66103	MX450, MX500, MX550, MXH675, MXTH675 (Alto= 81; Diámetro=22,2)	700214

Línea AZUL

SOPORTE DE CUCHILLAS (compatible con Toro)

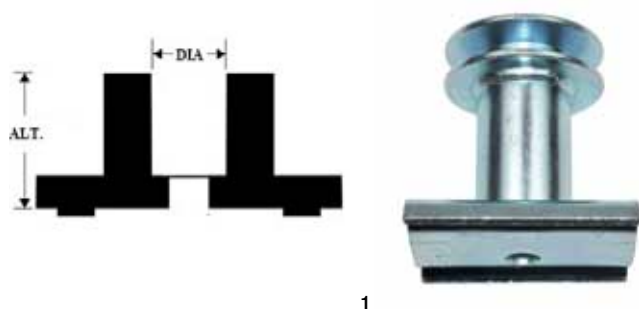

Nº	Referencia	Compatible con modelos	Ref. original
1	12 66104	20955/ 20655 (Alto= 75; Diámetro eje= 25,4)	106 3987

Línea AZUL

SOPORTE DE CUCHILLAS (compatible con Viking)

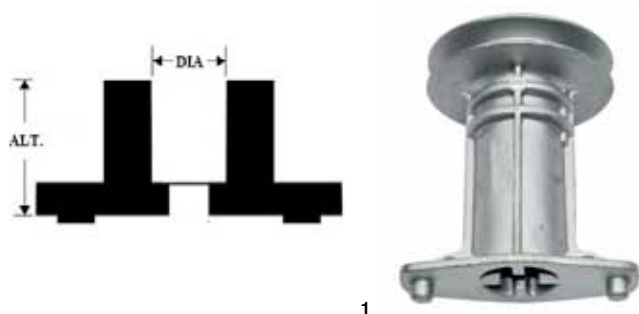

Nº	Referencia	Compatible con modelos	Ref. original
1	12 66105	MB 450/455/500 (Alto=86; Diámetro=22,2)	6118 702 5001

Línea AZUL

SOPORTE DE CUCHILLAS (Universal)

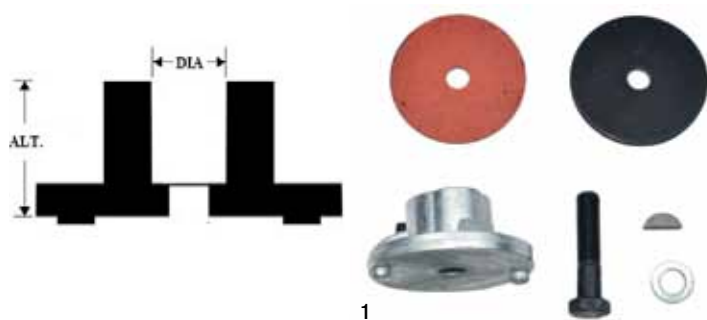

Nº	Referencia	Compatible con modelos
1	12 66106	Alto=27; Diámetro=22,2

Linea AZUL

TORNILLOS, ARANDELAS, BUJES Y POLEAS CUCHILLAS (compatible con CastelGarden)



Nº	Referencia	Compatible con modelos	Ref. original
1	12 66107	Tractores cortacésped Castelgarden, Stiga, Alpina - rosca izquierda	127356951
2	12 66108	Twin Cut - rosca derecha, S474L	12735694/0 / 12735694
3	12 66109	Kiwi, Bingo, NG410 / Stiga Collector 35EL, C350, C390	8100 4352/0
4	12 66110	NG504, TD534, NG464, R484	12735698
5	12 66111	Ventilador Castel Garden Kiwi/Bingo	22465602/0
6	12 66112	Polea NG504 TR, R434 TR, R484 TR / Stiga Turbo 47S, 53S, Collector 46S, 48S, 53S	22601904

Linea AZUL

TORNILLOS, ARANDELAS, BUJES Y POLEAS CUCHILLAS (compatible con Husqvarna)



Nº	Referencia	Compatible con modelos	Ref. original
1	12 66113	Tornillo cuchilla 32mmx3/8-24UNF, Husqvarna Jet + Rally + Craftsman	
2	12 66114	Tornillo con arandela modelos LT 125/131/151, LTH 126, CT 126, CTH 174/194	532 19 30 03
3	12 66115	Tornillo soporte cuchilla 82-225R Husqvarna LT/LTH/YT/CT	532 17 39 84
4	12 66116	Tornillo cuchilla -tuerca izquierda - Husqvarna CTH, Partner P185107HRB/ P12592RB, McCulloch	532 16 54 84
5	12 66117	Bujes Husqvarna LT131/151 McCulloch M13597/H - corte 38 - 54	532 18 72 92
6	12 66118	Buje 6 estrías Husqvarna CTH Partner P185107HRB, P12592RB	532 16 55 79
7	12 66119	Buje Husqvarna LT/YT/CT	532 13 07 94



TORNILLOS, ARANDELAS, BUJES Y POLEAS CUCHILLAS (compatible con AYP)



Nº	Referencia	Compatible con modelos	Ref. original
1	12 66120	AXP	532 12 87 74

Las referencias o alusiones a otras marcas hechas en el catálogo sólo son indicativas y sirven para la comprobación de nuestros productos. Suministramos SÓLO PIEZAS NO ORIGINALES.

TORNILLOS, ARANDELAS, BUJES Y POLEAS CUCHILLAS (compatible con Klippo y Kynast)



1



2

Línea
AZUL

Nº	Referencia	Compatible con modelos	Ref. original
1	12 66121	Arandela cuchilla Klippo 61x14x1,6	03.23-1
2	12 66122	Arandela cuchilla Kynast (agujero diam. 10mm)	00.3150.07

TORNILLOS, ARANDELAS, BUJES Y POLEAS CUCHILLAS (compatible con MTD)



1



2

Línea
AZUL

Nº	Referencia	Compatible con modelos	Ref. original
1	12 66123	Buje B 10, B 115, Spider 91, Junior	717 0900
2	12 66124	Buje 46 corte (con cuchilla incorporada)	618 0117

TORNILLOS, ARANDELAS, BUJES Y POLEAS CUCHILLAS (compatible con Murray)



1

Línea
AZUL

Nº	Referencia	Compatible con modelos	Ref. original
1	12 66125	Buje Murray 96, 102, 107 cm (nuevos modelos)	100120

TORNILLOS, ARANDELAS, BUJES Y POLEAS

CUCHILLAS (Universal)



1



2

3



4



5



6



7



8



9



11



10



12

Nº	Referencia	Compatible con modelos	Ref. original
1	12 66126	Set de arandelas cuchilla universal - diam.:10mm,12.7mm,14mm,16mm,18mm,19.5mm,21mm	
2	12 66127	Tornillo cuchilla 25mm x 3/8-24UNF	
3	12 66128	Tornillo cuchilla 38mm x 3/8-24UNF	
4	12 66129	Tornillo cuchilla 44mm x 3/8-24UNF	
5	12 66130	Arandela cuchilla 16mm - Bolsa de 10 unidades	
6	12 66131	Arandela cuchilla 9,5 x 41,2 mm	
7	12 66132	Tornillo cuchilla 51mm x 3/8-24UNF	
8	12 66133	Tornillo cuchilla 63mm x 3/8-24UNF	
9	12 66134	Tornillo cuchilla 57mm x 3/8-24UNF	
10	12 66135	Tornillo cuchilla 76mm x 3/8-24UNF	
11	12 66136	Arandela cuchilla 9,5mm - Bolsa de 10 unidades	
12	12 66137	Pomo con tornillo M8 x 50mm	



Las referencias o alusiones a otras marcas hechas en el catálogo sólo son indicativas y sirven para la comprobación de nuestros productos. Suministramos SÓLO PIEZAS NO ORIGINALES.

RECAMBIOS MOTORES 4 TIEMPOS



ACCESORIOS MOTOR



1

Nº	Referencia	Compatible con modelos
1	12 13001	Cuenta revoluciones+cuenta horas. Válido para motores 2T+4T

Línea AZUL

AGUJAS CARBURADOR (compatible con Honda)



1

2

Nº	Referencia	Compatible con modelos	Ref. original
1	12 32003	GX110/120/140/160	16011-ZG0-005 / 16011-ZE0-005
2	12 32004	GX240/270/340/390	16013-ZA0-931 / 16011-ZA0-931

Línea AZUL

BOBINAS DE ENCENDIDO (compatible con Honda)



1

2

3

Nº	Referencia	Compatible con modelos	Ref. original
1	12 16029	GX 120/140/160	20500-ZE1-003
2	12 16030	GX 240/340/390	30500-ZE2-033
3	12 16031	GX240/GX270/GX340/GX390	30500-ZF6-W02

Línea AZUL

BOBINAS DE ENCENDIDO (compatible con Briggs&Stratton)



Nº	Referencia	Compatible con modelos	Ref. original
4	12 16024	B&S 398811 (7-16 HP)	398811
5	12 16025	B&S 397358 (5 HP)	397358
6	12 16026	B&S 802574 (Quantum+Europa)	802574
7	12 16027	B&S 492341 (10-13 HP- Vanguard 9-12,5-14 HP)	492341
8	12 16028	B&S 398593 (2-4 HP)	398593

Línea AZUL

BOMBAS DE GASOLINA (Universal)



Nº	Referencia	Compatible con modelos
1	12 42001	Bomba de gasolina universal

Línea AZUL

BIELA MOTORES (compatible con Honda)



Nº	Referencia	Compatible con modelos	Ref. original
1	12 71001	GX140/160/200 (D1= 30 ; D2= 18; L= 60)	13200-ZE1-000
2	12 71002	GX240/270 (D1= 33,20 ; D2= 15,20; L= 75,20)	13200-ZE2-000
3	12 71003	GX370/390 (D1= 36 ; D2= 20; L= 84)	13200-ZE3-010
4	12 71004	GX110/120 (D1= 26,20 ; D2= 13,20; L= 53,70)	13200-ZE0-000
5	12 71005	GXV 160 (D1= 26 ; D2= 13; L= 54)	132A0-ZE1-000

Línea AZUL

BRIDA DE ADMISIÓN (compatible con Honda)



Nº	Referencia	Compatible con modelos	Ref. original
1	12 52028	GX140/160	16211-ZE0-000 / 16211-ZE1-000
2	12 52029	GX240/270	16211-ZE2-000
3	12 52030	GX340/390	16211-ZE2-W00 / 16211-ZE3-000 / 16211-ZF6-000

Línea AZUL

CABLES ACELERADOR (compatible con Husqvarna)



1



2

Nº	Referencia	Compatible con modelos	Ref. original
1	12 35023	Cortacésped Husqvarna Husky Jet	532 13 19 22
2	12 35024	Cortacésped Husqvarna Jet 49/50/51	532 85 14 63

Línea AZUL

CABLES ACELERADOR (compatible con Murray)

163



3

Nº	Referencia	Compatible con modelos	Ref. original
3	12 35025	42096 y otros	42096

Línea AZUL

CABLES ACELERADOR (compatible con MTD)



4



5

Nº	Referencia	Compatible con modelos	Ref. original
4	12 35026	Modelos 019/070/072/080/200	746-0801
5	12 35027	Compatible con MTD	746-084545

CABLES ACELERADOR (Universal)



6

Línea AZUL

Nº	Referencia	Compatible con modelos
6	12 35028	Universal

CABLE DE PARE (compatible con Murray)



1



2



3



4



5



6



7

Línea AZUL

Nº	Referencia	Compatible con modelos	Ref. original
1	12 73009	8416/4374946	8416/4374946
2	12 73010	672556. 3,5 HP	672556
3	12 73011	1101300. MTD Roper	1101300
4	12 73012	43828	43828
5	12 73013	43827	43827
6	12 73014	43830	43830
7	12 73015	290-102 (Cable de bloqueo)	290-102

CABLE DE PARE (compatible con MTD)



Nº	Referencia	Compatible con modelos	Ref. original
8	12 73016	746-0843. 428C. 5HP&Otros	746-0843
9	12 73017	746-0552	746-0552
10	12 73018	746-0500. MTD 040/050/060/080/090	746-0500
11	12 73019	746-0553. MTD 040/428/509	746-0553
12	12 73020	746-0554	746-0554

Línea AZUL

CAPUCHONES DE BUJÍA (compatible con Honda)



1

Nº	Referencia	Compatible con modelos	Ref. original
1	12 14005	Serie GX-GXV	30600-ZE1-013

Línea AZUL

CARBURADORES (compatible con Honda)



1



2



3

Nº	Referencia	Compatible con modelos	Ref. original
1	12 30034	GX160	16100-ZH8-810/16100-ZH8-W61
2	12 30035	GX270	16100-ZH0-W21/16100-ZH9-W21
3	12 30036	GX390	16100-ZF2-V01/16100-ZF2-V00

CARBURADORES

NEW!



4

Nº	Referencia	Compatible con modelos	Ref. original
4	12 30038	Walbro WB-32	WB-32

Línea AZUL

CARBURADORES (compatible con Robin)

NEW!



6

NEW!



7

NEW!



8



Nº	Referencia	Compatible con modelos	Ref. original
5	12 30039	Walbro HDA-176. Robin EC 08	HDA-176
6	12 30040	Walbro WJ-87. Robin EC 12	WJ-87
7	12 30041	Walbro HDA-172. Robin EC 12	HDA-172
8	12 30037	Walbro WYL-199 Robin EH-025	WYL-199-1

Línea AZUL

CASQUILLOS TRACCIÓN (compatible con Husqvarna)

NEW!



1

Nº	Referencia	Compatible con modelos	Ref. original
1	12 43085	Royal 43EL, 43ELS, 43S,43, 43SE. JONSERED 560RD/580RD	514 84 85 00

Línea AZUL

CEBADORES / BOMBINES CARBURADOR

(compatible con Briggs&Stratton)



1

Nº	Referencia	Compatible con modelos	Ref. original
1	12 29009	Briggs&Stratton 3,5-3,75-4 HP Quantum. Series 450, 500, 550, 450E, 500E, 550E, 575EX	694394

Línea
AZUL

CEBADORES / BOMBINES CARBURADOR

(compatible con Homelite/Honda)



2

Nº	Referencia	Compatible con modelos	Ref. original
2	12 29010	Homelite / Honda GX 22/25/31/35	UP 04802 / 16032-ZM3-004

Línea
AZUL

CONJUNTOS DE ARRANQUE (compatible con Honda)

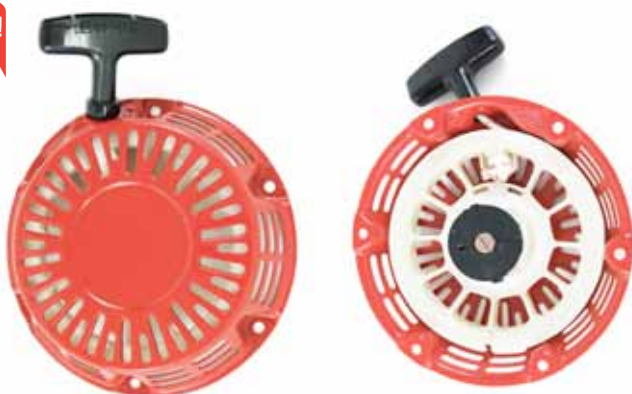

1

Nº	Referencia	Compatible con modelos	Ref. original
1	12 41025	GX110/120/140/160	28400-ZH8-013ZA

DEPÓSITO DE GASOLINA (compatible con Honda)



1



2

Nº	Referencia	Compatible con modelos	Ref. original
1	12 62005	GX160	17510-ZE1-020ZA
2	12 62006	GX370/GX390	17510-ZE3-010ZA

* Ver también tapones de gasolina

Línea AZUL

ESCAPES (compatible con Briggs&Stratton)



1



Nº	Referencia	Compatible con modelos	Ref. original
1	12 49019	Quantum (motores sin termostato)	490547/ 496106/ 4961065

Línea AZUL

FILTRO DE ACEITE (compatible con Briggs&Stratton)



1



Nº	Referencia	Compatible con modelos	Ref. original
1	12 11018	Motores Briggs&Stratton. Serie 3, Serie 4, Serie 7, Serie 8 / Vanguard	492932S

Línea AZUL

FILTRO DE AIRE (compatible con Briggs&Stratton)



Nº	Referencia	Compatible con modelos	Ref. original
1	12 10068	QUANTUM 3-5 HP hor. & 3,5-5 HP / Honda GC 135/160 GCV 135/160 Medidas en mm: 130x112x20	Briggs&Stratton 399959/ 491588 Honda 17211-ZL8-003
2	12 10069	Serie 800, 850E, 875EX, 950E	795066
3	12 10070	Serie 450, 500, 550, 450E, 500E, 550E, 575EX	272235
4	12 10071	Serie 450, 500, 550, 450E, 500E, 550E, 575EX	698369
5	12 10072	Serie 7	798897
6	12 10073	Serie 450E, 500E, 550E, 575EX	798452
7	12 10074	Serie 700E	792038 / 790388
8	12 10075	Compatible con B&S	690610/498596
9	12 10076	Pre-filtro de aire	273356S
10	12 10077	Filtro de aire	497725/494586
11	12 10078	Pre-filtro de aire	273185S

FILTRO DE AIRE (compatible con Briggs&Stratton)



Nº	Referencia	Compatible con modelos	Ref. original
12	12 10079	Pre-filtro de aire	491435S
13	12 10080	Filtro de aire	496894
14	12 10081	Pre-filtro de aire	796254
15	12 10082	Filtro de aire	394018
16	12 10083	Filtro de aire	697152; 797007
17	12 10084	Pre-filtro de aire	697292
18	12 10085	Pre-filtro de aire	272490
19	12 10086	Filtro de aire	692519
20	12 10087	Pre-filtro de aire	692520
21	12 10088	Filtro de aire	499486
22	12 10089	Pre-filtro de aire	793676
23	12 10090	Filtro de aire	799579

Las referencias o alusiones a otras marcas hechas en el catálogo sólo son indicativas y sirven para la comprobación de nuestros productos. Suministramos SÓLO PIEZAS NO ORIGINALES.

FILTRO DE AIRE (compatible con Honda)



Nº	Referencia	Compatible con modelos	Ref. original
24	12 10091	GX140/ GX160/ GX200	17210-ZE1-821/ 822/ 505
25	12 10092	GX240/ GX270	17210-ZE2-822/ 505
26	12 10093	GX340/ GX390	17210-ZE3-010/ 505
27	12 10094	Filtro de aire. Modelos GX150; GX200	17210-ZE6-505
28	12 10095	Pre-filtro de aire. Modelos GX150; GX200	17218-ZE6-505
29	12 10096	Filtro de aire. Modelos Honda GXV140 / Kohler XT675, Courage XT7 (X Series)	17211-ZG9-M00 / 1408301S
30	12 10097	Filtro de aire. Modelos GX110; GX120	17210-ZE0-505
31	12 10098	Filtro de aire. Modelos GXV140	17200-ZE7-003
32	12 10099	Filtro de aire. Modelos GXV160	17211-ZE7-W03
33	12 10100	Pre-filtro de aire . Modelos G200	17218-883-W21

FILTRO DE AIRE (compatible con Kohler)



Nº	Referencia	Compatible con modelos	Ref. original
34	12 10096	Filtro de aire. Modelos Kohler XT 675 / Courage XT7 (X Series); Honda GXV140	1408301S
35	12 10105	SV470/ SV480/SV530/SV540/SV590/SV600/ SV610	2008302

Línea AZUL

FILTRO DE AIRE (compatible con Kawasaki)



Nº	Referencia	Compatible con modelos	Ref. original
36	12 10102	FC-180V Medidas en mm: 170x58x27	11029-6001 (Reemplaza a 11013-2151)
37	12 10103	FC-150V	11013-2120; 11013-2175

Línea AZUL

FILTRO DE AIRE (compatible con Yanmar)



Nº	Referencia	Compatible con modelos	Ref. original
39	12 10110	L40/L48/L60/L70 (Serie LA)	114250-12580
40	12 10111	L75/L90/L100 (Serie LA)	114650-12590

Línea AZUL

FILTRO DE AIRE (compatible con Robin)



41



42



43



44

Nº	Referencia	Compatible con modelos	Ref. original
41	12 10106	EY15/EY08/EH122 (Tipo ciclón)	226-32610-07
42	12 10107	EH17/EY20/EY22	227-32610-07
43	12 10108	EX13/EX17/EX21	20A326 3600. Ref. Antigua: 277-32611-07
44	12 10109	EH41/EH36	267-35003-01

Línea AZUL

FILTRO DE GASOLINA (compatible con Briggs & Stratton)



1



2



3

Nº	Referencia	Compatible con modelos	Ref. original
1	12 11019	Filtro completo B&S 394 358, motor + bomba gasolina. 75 MICRAS	394358
2	12 11020	Filtro completo B&S 298090. Motor sin bomba de gasolina. 150 MICRAS	298090
3	12 11021	Filtro completo B&S, Nº 493629 y Nº691035. Motor sin bomba de gasolina. 60 MICRAS	493629

Línea AZUL

FILTRO DE GASOLINA (compatible con Honda)

NEW!



4

Nº	Referencia	Compatible con modelos
4	12 11023	Bolsa 10 filros de gasolina compatible con Honda GX120/160/390

Línea AZUL

FILTRO DE GASOLINA (Universal intercalado)



5

Nº	Referencia	Compatible con modelos
5	12 11022	Modelo WIX WF8130. 6-8 mm

Línea AZUL

INTERRUPTORES DE PARE (compatible con Honda)



1

Nº	Referencia	Compatible con modelos	Ref. original
1	12 22023	G100/150/200 y GX110/140/240/270/340	36100-ZE1-015

Línea AZUL

JUEGO DE JUNTAS MOTOR (compatible con Briggs&Stratton)

NEW!



1

Nº	Referencia	Compatible con modelos	Ref. original
1	12 33015	12HP	494241

Línea AZUL

JUEGO DE JUNTAS MOTOR (compatible con Honda)

NEW!



2

NEW!



3

NEW!



4

NEW!



5

Nº	Referencia	Compatible con modelos	Ref. original
2	12 33016	GXV390	06111-ZF5-406
3	12 33017	GX340	061A1-ZE3-T01 / 06111-ZE3-405
4	12 33023	GX390 13HP	061A1-ZF6-000
5	12 33019	GX160 5,5HP	061A1-ZE1-T01

Línea AZUL

JUEGO DE JUNTAS MOTOR (compatible con Robin)

NEW!

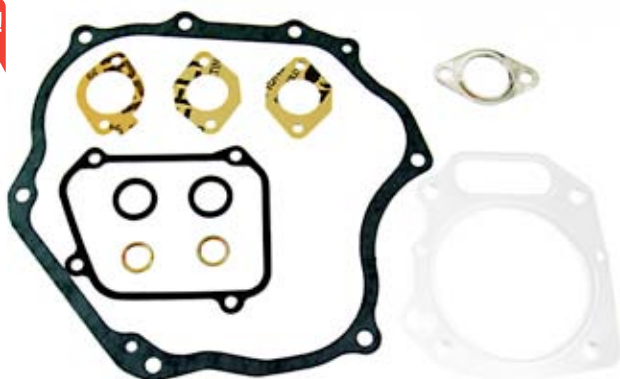

6

Nº	Referencia	Compatible con modelos	Ref. original
6	12 33020	Robin EH41, 13,5 HP	267-99001-27

Línea AZUL

KIT DE VÁLVULAS Y AGUJAS DE CARBURADOR

(compatible con Briggs&Stratton)



Nº	Referencia	Compatible con modelos	Ref. original
1	12 31058	B&S 18 HP. Vertical y Horizontal	394681
2	12 31059	B&S 3,4 HP Vertical	299060
3	12 31060	B&S 394682	394682
4	12 31061	B&S 293478	293478

Linea AZUL

LLAVES DE GASOLINA (compatible con Briggs&Stratton)



Nº	Referencia	Compatible con modelos	Ref. original
1	12 69001	B&S	399517
2	12 69002	B&S	494768

Linea AZUL

LLAVES DE GASOLINA (compatible con Honda)

NEW!



3

Nº	Referencia	Compatible con modelos	Ref. original
3	12 69003	GCV135/160/GXV50	16950-ZG9-M02

Línea AZUL

MUELLES DE REGULACIÓN (compatible con Briggs&Stratton)

NEW!



1

NEW!



2

NEW!



3

NEW!



4

NEW!



5

Nº	Referencia	Compatible con modelos	Ref. original
1	12 35030	B&S 5HP Quantum	262664
2	12 35031	B&S HP Quantum Series	262656
3	12 35032	262784	262784
4	12 35033	262505	262505
5	12 35034	3,5 HP	281058

Línea AZUL

SOLENOIDES (Universal)



1

Nº	Referencia	Compatible con modelos	Ref. original
1	12 40001	Husqvarna/Stiga/ Solo/Castelgarden	187361100

Línea AZUL

TUBOS DE GASOLINA (compatible con Honda)



Nº	Referencia	Compatible con modelos	Ref. original
1	12 28009	GX240/270/340/390. Medidas: 4,5 x 11mm,300 mm	95001-45222-40
2	12 28010	GCV135/160/GCV190A	17702-ZM0-000
3	12 28011	GCV135/160/GCV190A	15721-ZM0-000

Línea AZUL

TAPONES DE GASOLINA (compatible con Briggs & Stratton)



Nº	Referencia	Compatible con modelos	Ref. original
1	12 26013	Classic/ Quatum/ Sprint	497929
2	12 26014	Quantum- Nuevo	692046 / 793606

Línea AZUL

TAPONES DE GASOLINA (compatible con Honda)



Nº	Referencia	Compatible con modelos	Ref. original
3	12 27006	GX110/160	15600-ZG4-003 / 15600-735-003
4	12 26015	GX110/390. Plástico	17620-ZH7-023 / 17620-ZH7-013 / 17620-899-03
5	12 26016	GX110/390. Metal	17620-ZE2-W00 / 17620 890 010 / 17620 402 010
6	12 26017	GCV 135/160	17620-ZL8-013

Línea AZUL

TAPONES DE GASOLINA (compatible con Robin)

NEW!



7

Nº	Referencia	Compatible con modelos	Ref. original
7	12 26018	EY15/20/EC10	430430015

Línea
AZUL



KURIA®

MOTOGARDEN, S.A.

C/ Eduardo Pondal, s/n
Poligono de Sigüeiro, Parcela 58
15688 Sigüeiro-Oroso (A Coruña)

Tel. +34 981 69 63 08
Fax. +34 981 69 08 78

motogarden@motogarden.com
www.motogarden.com

ACCESORIOS ALKO Y SOLO



ACCESORIOS TRACTORES (Alko)

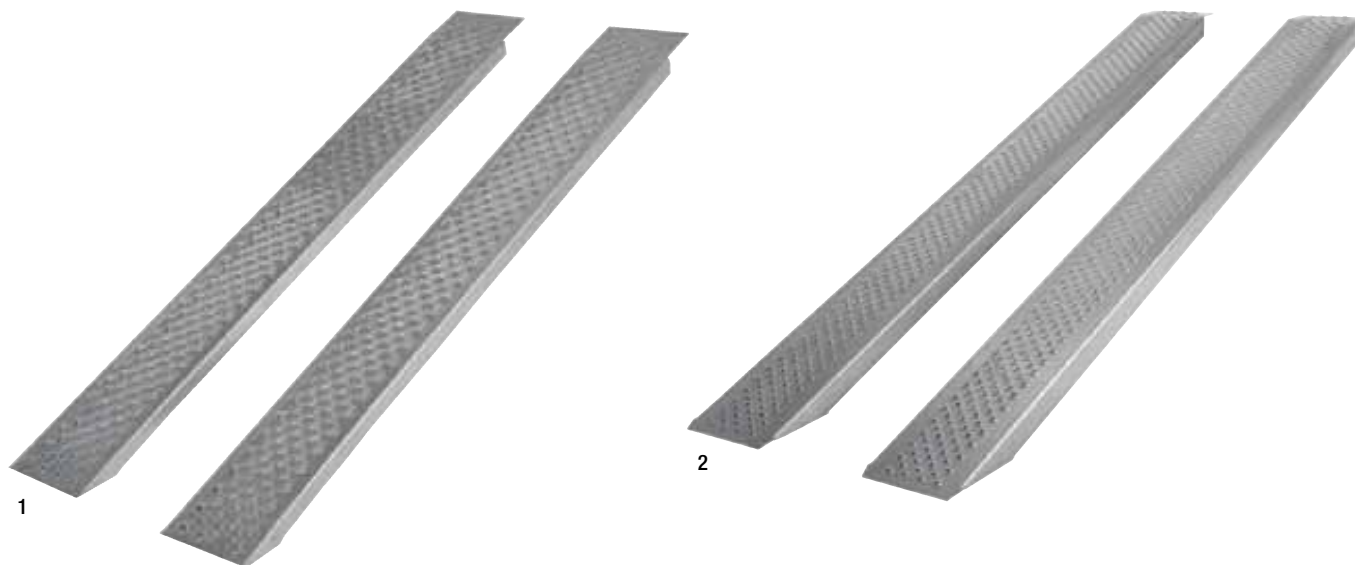

1

2



3

* También disponible en KURIL
(ref. 78 13025, pag. 10)



4



5

Nº	Referencia	Descripción
1	44 130585	Rampa recta 2m. 400 kg
2	44 130570	Rampa recta 2,5m. 1.000 kg
3	44 106118	Kit bomba extracción de aceite
4	44 130539	Rodillo 98 cm. Lleno de agua 140 Kg y lleno de arena 235 Kg
5	44 119104	Rodillo manual 50 cm. Vacío 13 Kg. Lleno de agua 72 Kg y lleno de arena 120 Kg

ACCESORIOS Y ROPA DE PROTECCIÓN

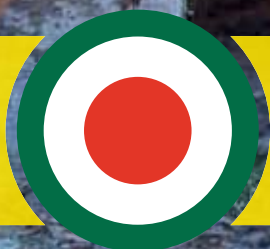

PANTALON DE PROTECCIÓN (clase 1 - 20m/s)

Cómodo pantalón con un diseño moderno, con calidad en los detalles. Cintura elástica con 2 bolsillos frontales. Excelente protección contra la motosierra (tipo A) con 9 capas en la parte delantera.

NEW!



DISPONIBLE A FINALES DE ABRIL

Homologados según normativa EN 381-5.
Clase 1 (20 m/s). Tipo A

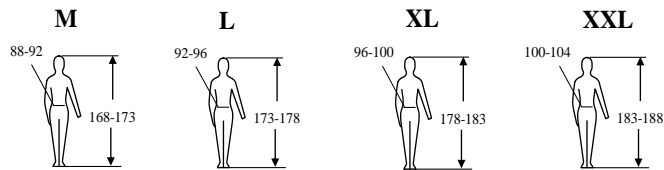

INFORMACIÓN POR TALLAS (En cm)

Talla	M	L	XL	XXL
Cintura	73	77	81	85
Interior pierna	80	81	81,5	82

Nº Referencia	Talla
1 78 60021	Talla M.
78 60022	Talla L
78 60023	Talla XL
78 60024	Talla XXL

Línea AZUL

BOTAS DE PROTECCIÓN (clase 2 - 24m/s)

Nuevas botas de protección fabricadas en cuero, diseñada en base al conocimiento de motoserristas profesionales. Fabricadas en piel y acolchadas. Protección con capas de alta resistencia, capaces de paralizar la sierra de cadena con una velocidad de hasta 24 m/s. Suela de PU de doble densidad+TPU y antideslizante, puntera de acero y plantilla anti-perforaciones de Kevlar.

NEW!



DISPONIBLE A FINALES DE ABRIL

Homologadas según normativa EN ISO 20345,
EN ISO 17249:2013 Categoría S3 SRC.
Clase 2 (24 m/s).

Nº Referencia	Talla
1 78 60012	Talla 39
78 60013	Talla 40
78 60014	Talla 41
78 60015	Talla 42
78 60016	Talla 43
78 60017	Talla 44
78 60018	Talla 45
78 60019	Talla 46
78 60020	Talla 47

1

GUANTES DE PROTECCIÓN (clase 0 - 16m/s)

Confortables guantes con protección anticorte en la mano izquierda. Fabricados con cuero de cabra en la palma y tela spandex en la parte posterior. Dispone de puño elástico fácilmente adaptable a la muñeca. Inmejorable comodidad y transpiración.



Homologados según normativa EN 381-7 CE Clase 0 (16 m/s).

Nº	Referencia	Talla
1	78 KM7825	Talla M
	78 KL7825	Talla L
	78 KXL7825	Talla XL

1

Línea AZUL

GAFAS DE PROTECCIÓN CLARA ANTIVAHO



Cumple norma EN 166.

Con sistema antivaho. Patillas ajustables. Cristales claros resistentes a rayaduras.

Nº	Referencia	Descripción
1	78 KSF98CA	Gafas de protección clara antivaho.

1

Línea AZUL

GAFAS DE PROTECCIÓN OSCURAS



Cumple norma EN 166.

Sistemas antivaho. Patillas ajustables. Cristales resistentes a rayaduras. Ofrecen una buena visibilidad en condiciones de ambiente soleado.

Nº	Referencia	Descripción
2	78 KSF98G	Gafas de protección oscura.

2

Línea AZUL

GAFAS DE PROTECCIÓN AMARILLAS



Cumple norma EN 166.

Sistemas antivaho. Patillas ajustables. Cristales resistentes a rayaduras. Ofrecen una elevada visibilidad en condiciones de poca luz.

Nº	Referencia	Descripción
3	78 KSF98A	Gafas de protección amarilla.

3

Línea AZUL

ACCESORIOS DE PROTECCIÓN



1



2



3



4



7



5



6



8

Nº	Referencia	Descripción
1	78 6099B952	Casco de protección motosierra. Casco de seguridad. Cumple normativa EN397. Visor de rejilla extra-grande y abatible. Incluye auriculares y barboquejo
2	78 KMZ2	Visor con pantalla metálica. Homologación CE
3	40 5120912	Pantalla profesional
4	78 60005	Visor con pantalla metálica y auriculares
5	78 KSR2	Protector auricular. Auricular simple con fleje cómodo. Homologación CE. Nivel sonoro (SNR 27 Db)
6	40 5135902	Auricular profesional
7	78 60001	Tapones oído. Nivel sonoro: 37dB. Pack de 3 pares. CE EN352-2
8	78 60002	Tapones oído con goma. Nivel sonoro: 37dB. Pack de 2 pares. CE EN352-2

MÁSCARAS DESECHABLES



Nº Referencia	Descripción
16 78 60003	Máscara desechable autofiltrante. CE EN 149: 2001-A1: 2009
17 78 60004	Máscara desechable autofiltrante. Con válvula de exhalación. CE EN 149: 2001-A1: 2009

Línea
AZUL

ESPINILLERAS DE PROTECCIÓN



Nº Referencia	Descripción
15 78 KZT1	Espinilleras de protección. Cierres elásticos regulables. Protección en rodillas.

Línea
AZUL



KURIA®

MOTOGARDEN, S.A.

C/ Eduardo Pondal, s/n
Poligono de Sigüeiro, Parcela 58
15688 Sigüeiro-Oroso (A Coruña)

Tel. +34 981 69 63 08
Fax. +34 981 69 08 78

motogarden@motogarden.com
www.motogarden.com

HERRAMIENTAS DE PODA



GUANTES DE PROTECCIÓN DE PODA

NEW!



1

Protectores en la mano izquierda.
Protección reforzada entre el pulgar y el índice y debajo de los cuatro dedos, a la altura de las cazoletas.
CE EN388

Línea AZUL

Nº	Referencia	Descripción	Talla
1	78 60007	Guante de protección de poda.	Talla 7
	78 60008	Guante de protección de poda.	Talla 8
	78 60009	Guante de protección de poda.	Talla 9
	78 60010	Guante de protección de poda.	Talla 10
	78 60011	Guante de protección de poda.	Talla 11

TIJERAS DE PODA

NEW!



1

NEW!



2

NEW!



3

NEW!



4

NEW!



5

Nº	Referencia	Descripción
1	78 74001	Tijera tradicional de poda ligera. Buen corte. Buen agarre a la mano. Alta durabilidad
2	78 74002	Tijera profesional de poda. Muy ligera. Buen corte. Se adapta bien a la mano
3	78 74003	Tijera de vendimia punta estrecha. Buen corte para jardín y calidad profesional de uña
4	78 74004	Tijera cortarramas by-pass. Hoja superior SK5 revestida de teflón. Hoja inferior hierro. Tubo de aluminio, PP &TPR. Longitud: 740 mm. Corte suave para leña gruesa. Bolsa de PVC para recubrir la cuchilla
5	78 74005	Tijera cortarramas by-pass. Hoja superior SK5 revestida de teflón. Hoja inferior hierro. Tubo de aluminio, PP &TPR. Longitud: 695 mm. Corte suave para leña gruesa. Bolsa de PVC para recubrir la cuchilla

TIJERAS DE PODA

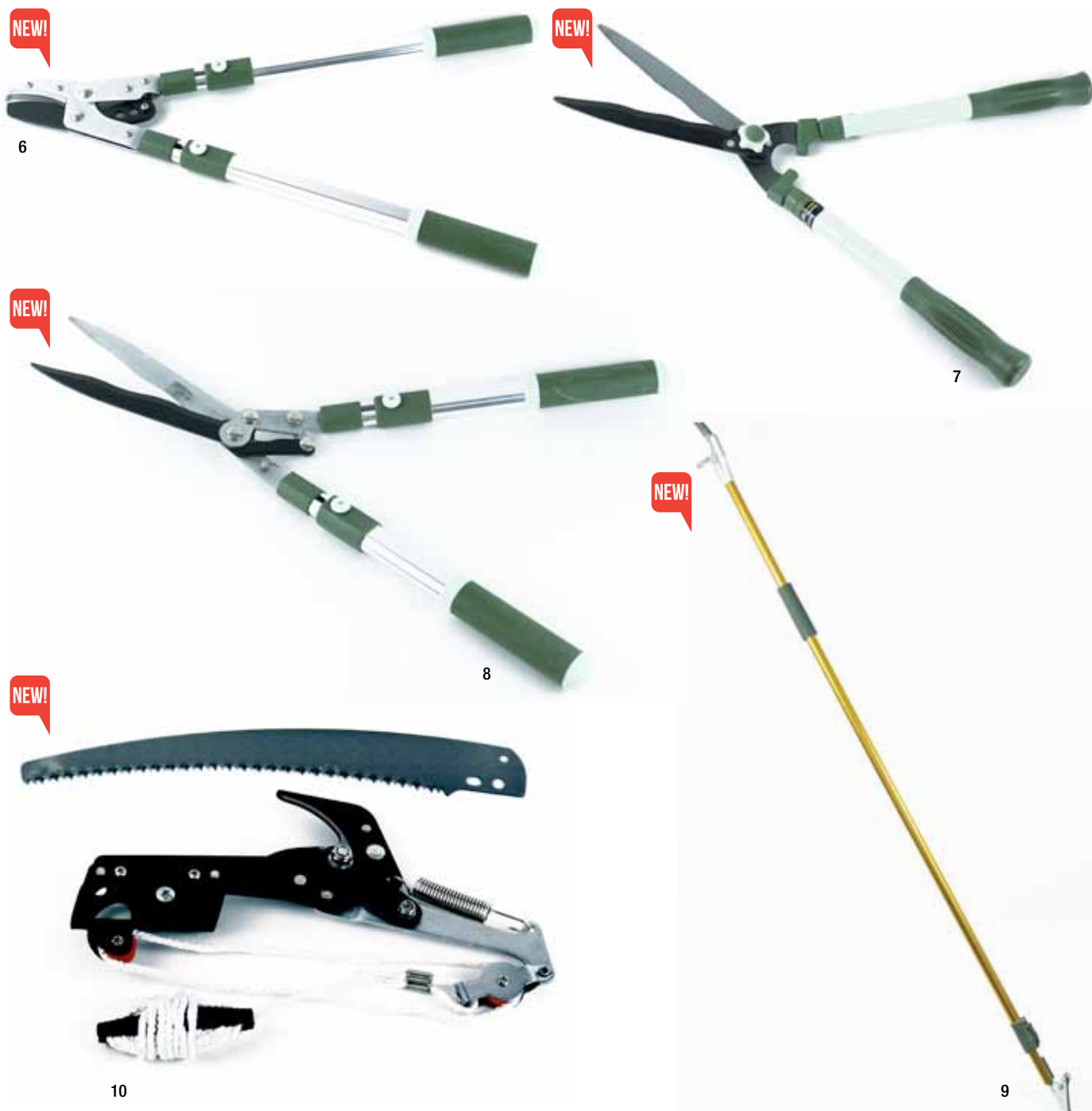

Nº	Referencia	Descripción
6	78 74006	Tijeras cortarramas 2 manos con mango extensible. Hoja superior SK5 revestida de teflón. Hoja inferior hierro. Tubo de aluminio, PP &TPR. Longitud: 685-1020 mm. Ligera. Buen corte. Bolsa de PVC para recubrir la cuchilla
7	78 74007	Tijera cortasetos 2 manos con mango extensible. Longitud: 645-835 mm. Ligera. Buen corte. Hoja superior SK5 revestida de teflón. Hoja inferior hierro. Tubo de aluminio, PP &TPR. Bolsa de PVC para recubrir la cuchilla
8	78 74008	Tijera cortasetos 2 manos con mango extensible. Longitud: 670-875 mm. Ligera. Buen corte. Hoja superior SK5 revestida de teflón. Hoja inferior hierro. Tubo de aluminio, PP &TPR. Bolsa de PVC para recubrir la cuchilla
9	78 74009	Mango telescópico de aluminio. Extensión: 1,5M-3M. Muy ligero
10	78 74010	Serrucho+tijera adaptable al mango telescópico. Recubierto de teflón. Hoja de acero de alto carbono



KURIA®

MOTOGARDEN, S.A.

C/ Eduardo Pondal, s/n
Poligono de Sigüeiro, Parcela 58
15688 Sigüeiro-Oroso (A Coruña)

Tel. +34 981 69 63 08
Fax. +34 981 69 08 78

motogarden@motogarden.com
www.motogarden.com

BATERIAS Y ACCESORIOS

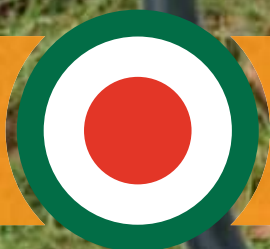

KUIRID[®]

BAYGAR

BATERIAS DE GEL SIN MANTENIMIENTO



NEW!

1

DIMENSIONES

151 (L) x 65(W) x 100(H) mm

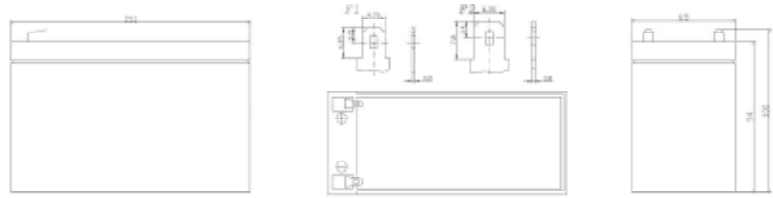

NEW!

2

Dimensions

Unit: m m Dimension: 181(L) x 77(W) x 167(H)

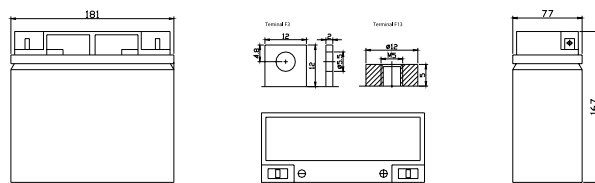

NEW!

3

DISPONIBLE A FINALES DE ABRIL

Dimensions

Unit: m m Dimension: 195(L) x 130(W) x 180(H)

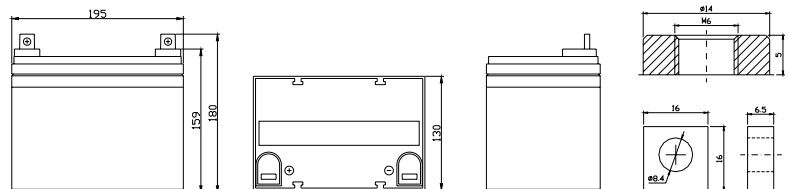

NEW!

4



NEW!

5



NEW!

6

Nº	Referencia	Descripción
1	78 75001	Batería Ritar RT 12-72 (12V 7,2 Ah) Medidas: 151x65x100
2	78 75002	Batería Ritar RT 12180 (12V 18 Ah) Medidas: 181x77x167
3	78 75006	Batería Ritar RA12-33C (12V 33 Ah) Medidas: 195x130x180
4	78 75003	Cargador batería 12V, 500mA. CE
5	78 75004	Comprobador universal de baterías 100 Amp.
6	78 75005	Comprobador universal de baterías 200 Amp.

Las referencias o alusiones a otras marcas hechas en el catálogo sólo son indicativas y sirven para la comprobación de nuestros productos. Suministramos SÓLO PIEZAS NO ORIGINALES.

ACEITES Y TANQUES

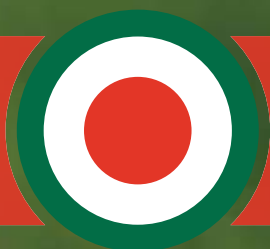

KURID®

BAYGAR

ACEITES Y TANQUES



Nº	Referencia	Descripción
1	24 569919021	Aceite cadena 5 Litros-4 uds/caja - 140 uds/pallet
2	24 569924031	Aceite 2T sintético 1 L c/dosificador-24 uds/caja - 576 uds/pallet
3	24 569924036	Aceite 2T sintético 5 L 5 uds/caja - 150 uds/pallet
4	24 569925031	Aceite 4T SAE 30 0,6L - 24 uds/caja - 864 uds/ pallet
5	78 5699705P	Bidón gasolina 5 litros homologado. Bidón de polietileno reforzado de alta densidad y tubo flexible. Homologado de acuerdo con la normativa europea UN 3H1/ Y1,2 /150.
6	78 5699700D	Bidón combinado homologado. Bidón con capacidad para 5 litros de combustible y 2,5 litros de aceite. Fabricado en polietileno reforzado de alta densidad y tubo flexible. Homologado de acuerdo con la normativa europea UN 3H2/ Y1,2 /150
7	24 51709002	Bidón 10l rojo
8	24 5699MG027	Gras multiusos 200grs

Las referencias o alusiones a otras marcas hechas en el catálogo sólo son indicativas y sirven para la comprobación de nuestros productos. Suministramos SÓLO PIEZAS NO ORIGINALES.

